

ZOLL®

E Series® Operator's Guide



The issue date for the **E Series Operator's Guide** (REF 9650-1210-01 Rev. T) is **June, 2014**.

If more than 3 years have elapsed since this date, contact ZOLL Medical Corporation to determine if additional product information updates are available.

Copyright © 2014 by ZOLL Medical Corporation. All rights reserved. AutoPulse, Base Power Charger, CPR Dashboard, CPR Index, CPR-D-padz, E Series, pedi-padz, Protocol Assist Code Markers, Real CPR Help, Rectilinear Biphasic, RescueNet, See-Thru CPR, SmartAlarms, stat-padz, SurePower and ZOLL are trademarks or registered trademarks of ZOLL Medical Corporation in the United States and/or other countries.

All other trademarks are the property of their respective owners.



ZOLL Medical Corporation

269 Mill Road
Chelmsford, MA USA
01824-4105



ZOLL International Holding B.V.

Newtonweg 18
6662 PV ELST
The Netherlands

TABLE OF CONTENTS

SECTION 1	GENERAL INFORMATION	1-1
	Product Description	1-1
	How to Use This Manual	1-2
	Manual Updates	1-2
	Unpacking	1-2
	Accessories	1-2
	Symbols Used on the Equipment	1-4
	Defibrillator Function	1-7
	Intended Use — Manual Operation.....	1-7
	Intended Use — Semiautomatic Operation (AED).....	1-7
	Contraindications for Semiautomatic Operation.....	1-7
	Defibrillator Complications	1-7
	Defibrillator Output Energy.....	1-7
	External Pacemaker Function (Pacer version only)	1-8
	Intended Use — Pacemaker	1-8
	Pacemaker Complications	1-8
	Pediatric Pacing	1-9
	Paddle and Electrode Options	1-9
	MFE Pad Application/Connection	1-9
	Monitor	1-10
	Recorder Function	1-10
	Batteries	1-10
	Internal Battery Charging	1-10
	External Battery Charger	1-10
	Diagnostics	1-10
	Safety Considerations	1-11
	WARNINGS - General	1-11
	Operator Safety.....	1-12
	Patient Safety.....	1-12
	CAUTIONS	1-13
	FCC Statement Regarding Bluetooth Operation.....	1-13
	Restarting the Device	1-14
	FDA Regulations	1-15
	Tracking Requirements.....	1-15
	Notification of Adverse Events	1-15
	Software License	1-15
	Service	1-15
	Returning a unit for service	1-15
	The ZOLL Serial Number	1-16

SECTION 2	OPERATING CONTROLS AND INDICATORS	2-1
	Code Markers	2-4
	Summary Report Function	2-4
	Summary Report Formats.....	2-4
	Defibrillation Format.....	2-5
	Pacer Format (Pacer version only)	2-6
	Heart Rate Alarm Activated Format	2-7
	VF Alarm Activated Format (Refer to Section 6).....	2-7
	Recorder On Format	2-7
	Analyze Format.....	2-8
	Manual Mode Activated	2-9
	Printing a Report	2-9
	Printing a Call Report	2-9
	Printing a Partial Summary Report	2-9
	Printing an Incident Log	2-9
	Adding a Patient Name and ID Number to a Report	2-10
	Modifying a Patient Name and ID Number	2-11
	Erasing Summary Report Memory	2-11
SECTION 3	MANUAL DEFIBRILLATION	3-1
	Emergency Defibrillation Procedure with Paddles or MFE Pads	3-1
	Troubleshooting	3-4
SECTION 4	ADVISORY DEFIBRILLATION	4-1
	Advisory Defibrillation	4-1
	Advisory Function Messages	4-4
	Warning Messages	4-4
	Troubleshooting	4-5
SECTION 5	AUTOMATED EXTERNAL DEFIBRILLATOR (AED) OPERATION ...	5-1
	AED Semiautomatic Operation	5-2
	Operating Messages	5-3
	AED Manual Mode Operation	5-5
	Troubleshooting	5-5
SECTION 6	SYNCHRONIZED CARDIOVERSION	6-1
	Synchronized Cardioversion	6-1
	Troubleshooting	6-3
SECTION 7	REAL CPR HELP	7-1
	Prepare the Patient and Attach the CPRD-to-MFC Connector	7-1
	Real CPR Help Field	7-1
	CPR Compressions Indicator.....	7-2
	CPR Idle Time Display	7-2

	FULLY RELEASE Prompt.....	7-2
	CPR Voice Prompts	7-2
	Compressions Bar Graph	7-2
	Displaying the CPR Compressions Bar Graph	7-3
	CPR Dashboard	7-3
	CPR Feedback Indicators and CPR Index.....	7-3
	CPR Rate and Depth Display	7-3
	CPR Idle Time Display.....	7-3
SECTION 8	SEE-THRU CPR.....	8-1
	Using See-Thru CPR.....	8-1
	Examples	8-1
SECTION 9	NONINVASIVE TEMPORARY PACING (PACER VERSION ONLY)..	9-1
	Noninvasive Temporary Pacing	9-1
	Special Pacing Applications	9-3
	Standby Pacing.....	9-3
	Asynchronous Pacing	9-4
	Pediatric Pacing	9-4
	Troubleshooting.....	9-4
SECTION 10	ECG MONITORING	10-1
	Introduction	10-1
	Preparations	10-1
	Electrode Placement	10-1
	Monitoring Electrodes Attachment.....	10-2
	Control Setting.....	10-2
	Spikes from Implanted Pacemakers	10-2
	Alarms.....	10-3
	Setting Alarm Limits	10-3
	Vital Sign Alarms.....	10-3
	Heart Rate Alarm Limits.....	10-3
	Suspending and Silencing Alarms	10-4
	Deactivating and Activating Alarms	10-4
	Smart Alarms	10-4
	Recorder Operation	10-4
	Diagnostic Bandwidth	10-4
	5-Lead Monitoring.....	10-5
	Changing from 3-Lead Monitoring	10-5
	Changing from 5-Lead ECG Monitoring.....	10-5
	Simultaneous 3-Lead Printing	10-5
	Vital Signs Trending	10-5
	Viewing Vital Signs Trending Data on the Display.....	10-5
	Printing a Vital Signs Trend Report.....	10-6

NIBP Trend Operation	10-6
Clearing Vital Signs Trend Records.....	10-7
SECTION 11 GENERAL MAINTENANCE	11-1
Inspection.....	11-1
Cleaning.....	11-1
Cleaning the Recorder Printhead.....	11-1
Testing the E Series Unit.....	11-1
Testing the Stripchart Recorder	11-1
Testing the Defibrillator (Semiautomatic Mode).....	11-2
Testing the Defibrillator (Manual Mode).....	11-2
Testing the Pacer (Pacer Version Only)	11-3
Changing Recorder Paper.....	11-4
Setting Time and Date	11-5
Manual Method	11-5
Automated Dial-up Method	11-5
GPS Synchronization.....	11-6
Operator's Shift Checklist for E Series Products (Manual).....	11-7
Operator's Shift Checklist for E Series Products (Semiautomatic)	11-8
SECTION 12 BATTERY MANAGEMENT	12-1
Battery Care.....	12-1
Battery Life Expectancy	12-1
LOW BATTERY Message.....	12-1
Changing the Battery Pack	12-1
Charging and Testing Battery Packs	12-2
Top Panel Battery LEDs	12-2
Troubleshooting	12-2
Achieving Optimal Battery Pack Performance.....	12-3
SECTION 13 TROUBLESHOOTING GUIDELINES	13-1
Monitor.....	13-1
Recorder	13-3
Pacer (Pacer version only).....	13-4
Defibrillator.....	13-5
AC Charger.....	13-7
APPENDIX A SPECIFICATIONS	A-1
General.....	A-1
Pacemaker (Pacer version).....	A-2
ECG Monitoring.....	A-3
CPR Monitoring.....	A-4
Display	A-5
Recorder	A-5

PCMCIA Card	A-5
Battery Packs	A-5
Guidance and Manufacturer's Declaration — Electromagnetic Emissions	A-7
Electromagnetic Immunity Declaration (EID).....	A-8
EID for Life-Support Functions	A-9
Recommended Separation Distances from RF Equipment for E Series Life-Support Functions	A-10
EID for Non-Life-Support Functions	A-11
Recommended Separation Distances from RF Equipment for E Series Non-Life-Support Functions	A-12
Rectilinear Biphasic Waveform Characteristics	A-13
Clinical Trial Results for the Biphasic Waveform	A-21
Randomized Multi-Center Clinical Trial for Defibrillation of Ventricular Fibrillation (VF) and Ventricular Tachycardia (VT)	A-21
Randomized Multi-Center Clinical Trial for Cardioversion of Atrial Fibrillation (AF)	A-22
Synchronized Cardioversion of Atrial Fibrillation	A-23
Shock Conversion Estimator.....	A-24
ECG Analysis Algorithm Accuracy	A-27
Clinical Performance Results.....	A-27
 APPENDIX B MEDICAL REPORT CAPABILITY	 B-1
PCMCIA Data Card.....	B-1
Installing the PCMCIA Data Card.....	B-1
Erasing a Memory Card.....	B-1
Transferring Data to a PC with a PCMCIA Data Card Reader	B-2
Uploading Memory Card Data or Trend History to a PC or Handheld	B-2
RS-232 Serial Port.....	B-2
Bluetooth Transceiver (Optional)	B-2
Communication Settings.....	B-3
Transferring Data	B-3
Activating Automatic Data Transmission.....	B-4
Transmitting 12-Lead Patient Records	B-5
Troubleshooting.....	B-5

(This page intentionally left blank.)

SECTION 1

GENERAL INFORMATION

NOTE: Your E Series[®] may or may not contain all the features listed in this manual, depending on your particular configuration.

Product Description

The ZOLL[®] E Series products combine defibrillation, ECG display, advanced monitoring capabilities, and Noninvasive Transcutaneous Pacing (NTP) with communication, data printing and recording capabilities in a single lightweight portable instrument. The unit has been designed for all resuscitation situations; its small, compact, lightweight design makes it ideal for accompanying patients during transport. The product is powered by alternating current (AC) or direct current (DC) mains and an easily replaced battery pack that is quickly recharged in the device when it is connected to AC or DC mains. In addition, the unit's batteries may be recharged and tested using ZOLL Base Power Charger[™] 4X4 or ZOLL SurePower[™] Charger systems designed for standard interchangeable ZOLL battery packs.

The product is designed for use in both the hospital and the rugged EMS environment. All of its features add to its durability in hospital applications. The device is a versatile automated external defibrillator with manual capabilities and may be configured to operate in Manual, Advisory or Semiautomatic modes. Semiautomatic versions of the device have a distinctive front panel with a single ON position. Conventional devices, which can be configured for Manual, Advisory or Semiautomatic operation, have a standardized ZOLL operator interface. When operating in manual configuration, the device operates as a conventional defibrillator where the device's charging and discharging is fully controlled by the operator. In Advisory and Semiautomatic modes, some features of the device are automated and a sophisticated detection algorithm is used to identify ventricular fibrillation and determine the appropriateness of defibrillator shock delivery. Units may be configured to automatically charge, analyze, recharge, and prompt the operator to "PRESS SHOCK", depending on local protocols. The unit is switched from Semiautomatic mode to Manual mode for ACLS use by pressing the appropriate soft key on the front panel.

The E Series assists caregivers during cardiopulmonary resuscitation (CPR) by evaluating the rate and depth of chest compressions and providing feedback to the rescuer. Real CPR Help[®] requires the use of CPR-D-padz[®] and the CPRD-to-MFC connector. Real CPR Help is available in E Series units with software version 3.00.000 or higher.

Information regarding the unit's operation, patient ECG, and other physiological waveforms is displayed on a large 5.63 inch diagonal display, which provides high contrast and visibility under virtually all lighting conditions. Operating and warning messages are displayed on the monitor and the unit can also be configured with voice prompts to alert the user to unit status. Self-diagnostic tests are performed when the instrument is turned on as well as periodically during operation.

A sophisticated data collection system, an internal summary report feature with printer, and PCMCIA cards are available for this unit. A PCMCIA card can be installed in the unit to record ECG and virtually all device data when the device is turned on. The data stored on the PCMCIA card can be reviewed and archived on a properly equipped personal computer using RescueNet[®] Code Review for Windows software.

An annotating strip chart recorder is included to provide immediate documentation and summary report functions about patient care and treatment during use.

Some E Series products are intended for use in the Semiautomatic mode by first responders and emergency medical technicians certified by an appropriate federal, state or local government authority. Some E Series products are intended for use in Manual mode by personnel certified by appropriate federal, state or local authority to provide advanced life support care.

Some E Series products are intended for use in the pre-hospital emergency medical care setting, indoors and outdoors, including first response vehicles, fire vehicles, basic and advanced level ambulances as well as by both Basic Life Support (BLS) and Advanced Cardiac Life Support (ACLS) staff in hospitals under protocol control.

How to Use This Manual

The E Series Operator's Guide provides information operators need to know for the safe and effective use and care of the E Series products. Before operating this device, be sure to read and understand all the information contained within.

This manual is organized for Manual mode operators, Advisory mode operators and Semiautomatic mode operators. If you will only use the device in Manual mode or Advisory mode you do not need to read Section 5. If you will only use the device in Semiautomatic mode you do not need to read Sections 3, 4, or 6.

Please read "Safety Considerations" on page 1-11 thoroughly.

Procedures for daily checkout and unit care are described in "General Maintenance" on page 11-1.

This manual is supplemented by inserts for options available on the E Series. These inserts contain additional warnings, precautions, and safety-related information.

Manual Updates

An issue or revision date for this manual is shown on the front cover.

If more than three years have elapsed since this date, contact ZOLL Medical Corporation to determine if additional product information updates are available.

All users should carefully review each manual update to understand its significance and then file it in its appropriate section within this manual for subsequent reference.

Product documentation is available through the ZOLL website at www.zoll.com. From the Products menu, choose Product Documentation.

Unpacking

Before unpacking the E Series unit, carefully inspect each container for damage. If the shipping container or cushion material is damaged, it should be kept until the contents have been checked for completeness and the instrument has been checked for mechanical and electrical integrity.

If the contents are incomplete, if there is mechanical damage, or if the instrument does not pass its electrical self-test, North American customers should call ZOLL Medical Corporation (1-800-348-9011). International customers should contact the nearest ZOLL authorized representative. If the shipping container is damaged, also notify the carrier.

Accessories

The following table describes accessories available for use with the E Series.

















Electrodes/Pads, Paddles, and Connectors	REF
Adult, Multi-Function Pacing/Defibrillation stat-padz [®] (12 pair/box)	8900-4003
Pediatric, Multi-Function Pacing/Defibrillation pedi-padz [®] (6 pair/box)	8900-2065
External Paddle Assembly Apex/Sternum with built in pediatric electrodes	8000-1010-01
CPR-D-padz	8900-0800-01
CPRD-to-MFC Connector	8000-0370
Cables	REF
Multi-Function Cable Assembly for use with external paddles or multi-function electrode pads	8000-0308-01 (standard 8') 8000-0308-02 (extended 12')
AAMI 3-Lead ECG Patient Cable	8000-0025-02 (6') 8000-0025 (12')
IEC 3-Lead ECG Patient Cable	8000-0026

AAMI 5-Lead Wire ECG Patient Cable	8000-1005-01
IEC 5-Lead Wire ECG Patient Cable	8000-0091
Power Cord Extension Cable (12")	8000-0730
Batteries and Chargers	REF
ZOLL Base PowerCharger 4x4 Battery Charger	8050-0012-01
Smart Battery Pack	8004-0103-01
SmartReady Battery Pack	8004-0104-01
ZOLL SurePower Charger	8050-0030-01
SurePower defibrillator battery	8019-0535-01
Miscellaneous	REF
Storage Bag Set	8000-0916
Recorder Paper, 80mm Fan Fold	8000-0301 (20 packages) 8000-0302 (10 packages)
Defibrillator Gel	8000-0053
PCMCIA Data Cards (2 per package)	8000-0551 (8Mb) 8000-0552 (16Mb) 8000-0553 (32Mb)
RS232 Data Transfer Cable	8000-0605-01
ECG Simulator	8012-0206

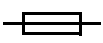
* The terms "ZOLL Multi-Function Electrode (MFE) Pads" and "MFE Pads" are used interchangeably throughout this manual.

Symbols Used on the Equipment

Any or all of the following symbols may be used in this manual or on this equipment:

	Type B equipment.
	Type BF equipment.
	Type CF equipment.
	Defibrillator-proof type BF equipment.
	Defibrillator-proof type CF equipment.
	Attention, consult accompanying documents.
	Fragile, handle with care.
	Keep dry.
	This end up.
	Temperature limitation.
	Fusible Link.
	Equipotentiality.
	Protective (earth) ground terminal.
	DANGER High Voltage present.
	Alternating current.
	Direct current.



Contains lead. Recycle or dispose of properly.



Keep away from open flame and high heat.



Do not open, disassemble, or intentionally damage.



Do not crush.



Nonrechargeable battery



Do not discard in trash. Recycle or dispose of properly.



Date of manufacture.



Use by.



Latex-free.



Do not reuse.



Do not fold.



Not sterile.



Nonionizing electromagnetic radiation.



Return to a collection site intended for waste electrical and electronic equipment (WEEE). Do not dispose of in unsorted trash.



Manufacturer.



Authorized representative in the European Community.



Serial Number.



Catalogue number.



Consult instructions for use.



Protected against ingress of solid foreign objects ≥ 2.5 mm in diameter.
Protected against splashing water.

Defibrillator Function

The E Series products contain a DC defibrillator capable of delivering up to 200 joules of energy. It may be used in synchronized mode to perform synchronized cardioversion by using the R-wave of the patient's ECG as a timing reference. The unit uses paddles or disposable, pre-gelled, MFE Pads for defibrillation.

The E Series products must be prescribed for use by a physician or medical advisor of an emergency response team.

Intended Use — Manual Operation

Use of the E Series products in the Manual mode for defibrillation is indicated on victims of cardiac arrest where there is apparent lack of circulation as indicated by these three conditions:

- Unconsciousness
- Absence of breathing, and
- Absence of pulse.

This product should be used only by qualified medical personnel for converting ventricular fibrillation and rapid ventricular tachycardia to sinus rhythm or other cardiac rhythms capable of producing hemodynamically significant heart beats.

In Manual mode, the E Series unit may also be used for synchronized cardioversion to terminate atrial fibrillation (AF) or ventricular tachycardias (VT) by using the R-wave of the patient's ECG as a timing reference. A qualified physician must decide when synchronized cardioversion is appropriate.

The Advisory function should be used to confirm ventricular fibrillation and wide complex ventricular tachycardia (greater than 150 beats per minute) in patients meeting the three conditions indicating lack of circulation (previously listed).

Intended Use — Semiautomatic Operation (AED)

The E Series AED unit is designed for use by emergency care personnel who have completed training and certification requirements applicable to the use of a defibrillator where the device operator controls delivery of shocks to the patient.

They are specifically designed for use in early defibrillation programs where the delivery of a defibrillator shock during resuscitation involving CPR, transportation, and definitive care are incorporated into a medically-approved patient care protocol.

Use of the device in the Semiautomatic mode for defibrillation is indicated on victims of cardiac arrest where there is apparent lack of circulation.

Specifications for the ECG rhythm analysis function are provided at the end of this section.

Intended Use — CPR Monitoring

The CPR monitoring function provides visual and audio feedback designed to encourage rescuers to perform chest compressions at the AHA/ERC recommended rate of 100 compressions per minute. Voice and visual prompts encourage a minimum compression depth of at least 1.5 (3.8 cm) or 2.0 inches (5.0 cm), depending on the configuration, for adult patients.

The CPR monitoring function is not intended for use on patients under 8 years of age.

Contraindications for Semiautomatic Operation

Do not use the unit's AED function on patients under 8 years of age.

The rhythm analysis function may not reliably identify ventricular fibrillation in the presence of an implanted pacemaker. Inspection of the electrocardiogram and clinical evidence of cardiopulmonary arrest should be the basis for any treatment of patients with implanted pacemakers.

Do not use the rhythm analysis function during patient movement on a stretcher or in an ambulance or other conveyance. A patient must be motionless during ECG analysis. Do not touch the patient during analysis. Cease all movement of the stretcher or vehicle prior to analyzing the ECG. If you are using the device in an emergency vehicle, bring the vehicle to a halt before activating the analysis function.

Defibrillator Complications

Inappropriate defibrillation or cardioversion of a patient (e.g., with no malignant arrhythmia) may precipitate ventricular fibrillation, asystole, or other dangerous arrhythmias.

Defibrillation without proper application of electrode pads or paddle electrolyte gel may be ineffective and cause burns, particularly when repeated shocks are necessary. Erythema or hyperemia of the skin under the paddles or MFE Pads often occurs; this effect is usually enhanced along the perimeter of the paddle or electrode. This reddening should diminish substantially within 72 hours.

Defibrillator Output Energy

The E Series products may deliver up to 200 joules into a 50 ohm impedance. The energy delivered through the chest wall, however, is determined by the patient's transthoracic impedance. An adequate amount of electrolyte gel must be applied to the paddles and a force of 10-12 kilograms (22-26.4 lbs) must be applied to each paddle in order to minimize this impedance. If MFE pads are used, make sure that they are properly applied. (Instructions for proper application are located in "MFE Pad Application/Connection" on page 1-9).

External Pacemaker Function (Pacer version only)

Some E Series products may include an optional transcutaneous demand pacemaker consisting of a pulse generator and ECG sensing circuitry. Non-invasive Transcutaneous Pacing (NTP) is an established and proven technique. This therapy is easily and rapidly applied in both emergency and non-emergency situations when temporary cardiac stimulation is indicated.

Proper operation of the device, together with correct electrode placement, is critical to obtaining optimal results. Every operator must be thoroughly familiar with these operating instructions.

The output current of the pacemaker is continuously variable from 0 to 140 mA. The rate is continuously variable from 30 to 180 pulses per minute (ppm).

The pacing output pulse is delivered to the heart by specially designed ZOLL MFE Pads placed on the back and the precordium.

The characteristics of the output pulse, together with the design and placement of the electrodes, minimize cutaneous nerve stimulation, cardiac stimulation threshold currents, and reduce discomfort due to skeletal muscle contraction.

The unique design of the E Series products allow clear viewing and interpretation of the electrocardiogram (ECG) on the display without offset or distortion during external pacing.

Intended Use — Pacemaker

This product may be used for temporary external cardiac pacing in conscious or unconscious patients as an alternative to endocardial stimulation.

Note: This device must not be connected to internal pacemaker electrodes.

The purposes of pacing include:

- **Resuscitation from standstill or bradycardia of any etiology**

Noninvasive pacing has been used for resuscitation from cardiac standstill, reflex vagal standstill, drug induced standstill (due to procainamide, quinidine, digitalis, b-blockers, verapamil, etc.) and unexpected circulatory arrest (due to anesthesia, surgery, angiography, and other therapeutic or diagnostic procedures). It has also been used for temporary acceleration of bradycardia in Stokes-Adams disease and sick-sinus syndrome. It is safer, more reliable, and more rapidly applied in an emergency than endocardial or other temporary electrodes.

- **As a standby when standstill or bradycardia might be expected**

Noninvasive pacing may be useful as a standby when cardiac arrest or symptomatic bradycardia might be expected due to acute myocardial infarction, drug toxicity, anesthesia or surgery. It is also useful as a temporary treatment in patients awaiting pacemaker implants or the introduction of transvenous therapy. In standby pacing applications, noninvasive pacing may provide an alternative to transvenous therapy that avoids the risks of displacement, infection, hemorrhage, embolization, perforation, phlebitis and mechanical or electrical stimulation of ventricular tachycardia or fibrillation associated with endocardial pacing.

- **Suppression of tachycardia**

Increased heart rates in response to external pacing often suppress ventricular ectopic activity and may prevent tachycardia.

Pacemaker Complications

Ventricular fibrillation does not respond to pacing and requires immediate defibrillation. Therefore, the patient's dysrhythmia must be determined immediately, so that you can employ appropriate therapy. If the patient is in ventricular fibrillation and defibrillation is successful but cardiac standstill (asystole) ensues, you should use the pacemaker.

Ventricular or supraventricular tachycardias may be interrupted with pacing but in an emergency or during circulatory collapse, synchronized cardioversion is faster and more certain. (See "Synchronized Cardioversion" on page 6-1).

Electromechanical dissociation may occur following prolonged cardiac arrest or in other disease states with myocardial depression. Pacing may then produce ECG responses without effective mechanical contractions, and other treatment is required.

Pacing may evoke undesirable repetitive responses, tachycardia, or fibrillation in the presence of generalized hypoxia, myocardial ischemia, cardiac drug toxicity, electrolyte imbalance, or other cardiac diseases.

Pacing by any method tends to inhibit intrinsic rhythmicity. Abrupt cessation of pacing, particularly at rapid rates, can cause ventricular standstill and should be avoided.

Noninvasive Temporary Pacing may cause discomfort of varying intensity, which occasionally can be severe and preclude its continued use in conscious patients.

Similarly, unavoidable skeletal muscle contraction may be troublesome in very sick patients and may limit continuous use to a few hours. Erythema or hyperemia of the skin under the MFE Pads often occurs; this effect is usually enhanced along the perimeter of the electrode.

This reddening should substantially lessen within 72 hours.

There have been reports of burns under the anterior electrode when pacing adult patients with severely restricted blood flow to the skin. Prolonged pacing should be avoided in these cases and periodic inspection of the underlying skin is advised.

There are reports of transient inhibition of spontaneous respiration in unconscious patients with previously available units when the anterior electrode was placed too low on the abdomen.

WARNING! This device must not be connected to internal pacemaker electrodes.

Pediatric Pacing

Pacing can be performed on pediatric patients weighing 33lbs / 15kg or less using special ZOLL pediatric MFE Pads. Prolonged pacing (in excess of 30 minutes), particularly in neonates, could cause burns. Periodic inspection of the underlying skin is recommended.

Paddle and Electrode Options

The E Series products will defibrillate, cardiovert and monitor ECG using either defibrillation paddles or ZOLL Multi-Function Electrode (MFE) Pads.

The pacer version of the E Series paces using ZOLL MFE Pads.

ENERGY SELECT, CHARGE, and SHOCK controls are located on the paddles and front panel. When using MFE Pads, you must use the controls on the front panel of the unit. To switch from paddles to MFE Pads, remove the Multi-Function cable from the apex paddle and connect the MFE pads to the Multi-Function cable.

You cannot activate the Advisory function unless MFE Pads are attached to the Multi-Function Cable and used as the ECG monitoring lead.

Adult and pediatric MFE Pads, stat-padz, and ECG electrodes (not the ECG cable) are disposable, single-use items.

MFE Pad Application/Connection

This section describes how to prepare the patient and attach and connect MFE pads. Attach the MFE pads according to the instructions on the electrode packaging.

1. Prepare the patient by:
 - Removing all clothing covering the patient's chest.
 - Drying chest if necessary
 - Clipping excessive chest hair, if necessary, to ensure proper adhesion of electrodes.

CAUTION

Only use pads that are well within the expiration date indicated on the package. Failure to do so could result in false patient impedance readings and may affect delivered energy.

2. Connect MFE Pads to the multi-function cable (if not already connected), as shown below.

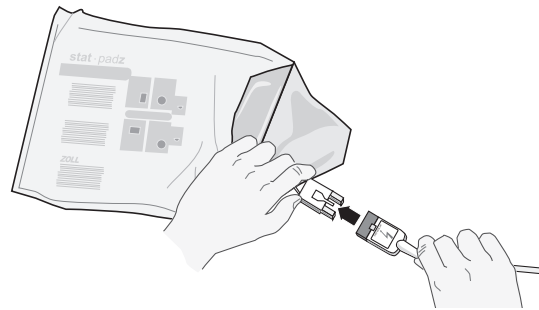

WARNING

Poor adherence and/or air under the MFE Pads can lead to the possibility of arcing and skin burns.

3. Open the pad packaging and apply one edge of the pad securely to the patient.
4. Roll the pad smoothly from that edge to the other being careful not to trap any air pockets between the gel and skin.

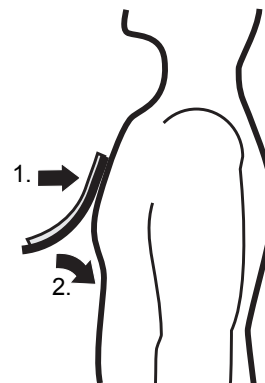

If it is not possible to place the back MFE Pad on the patient's back, place it on the standard apex position of the apex-sternum configuration. Effective defibrillation will result, but pacing with the device is usually less effective.

Ensure that all MFE Pads are making good contact with the patient's skin and are not covering any part of the ECG electrodes. Note that:

- If the MFE Pads are not making good contact with the patient, the messages *CHECK PADS* and *POOR*

PAD CONTACT are alternately displayed, and energy will not be delivered

- If a short circuit exists between MFE Pads, the message *DEFIB PAD SHORT* is displayed.

Monitor

The patient's ECG is monitored by connecting the patient to the unit via the 3 lead or 5 lead wire patient cable, MFE Pads, or through the paddles. Four seconds of ECG is presented on the display along with the following information:

- averaged heart rate, derived from measuring R to R intervals
- lead selections — I, II, III, aVR, aVL, aVF, V (with ECG cable), PADDLES, or PADS (APLS if connected to AutoPulse® Plus)
- ECG size — 0.5, 1, 1.5, 2, 3 cm/mV
- pacemaker output in milliamps (Pacer version only)
- pacemaker stimulus rate in pulses per minute (Pacer version only)
- defibrillator output in joules
- other operational prompts, messages, and diagnostic codes

Monitoring or diagnostic ECG bandwidth is selectable.

Recorder Function

The strip recorder normally operates in the delay mode (6 seconds) to ensure capture of critical ECG information. You manually activate the recorder by pressing the **RECORDER** button. It is activated automatically whenever a defibrillation shock is delivered, a heart rate alarm occurs, or the rhythm analysis function is activated. You can deactivate the stripchart recorder during these events.

Batteries

The E Series products use easily replaced sealed, lead-acid or lithium-ion battery packs that, when new and fully charged, provide at least 2.5 hours of monitoring. Use of the defibrillator, strip chart recorder, and pacemaker reduces this time.

When a *LOW BATTERY* message appears on the display and the unit emits two beeps in conjunction with the displayed message, you must replace and recharge the battery.

Internal Battery Charging

You can charge the battery within the device via AC (alternating current) mains, or an optional DC (direct current) input.

When the E Series products are plugged into AC mains or to a DC power supply, the CHARGER ON indicators operate in the following manner:

- The orange-yellow CHARGER ON indicator illuminates continuously whenever the device is turned OFF and charging the battery or whenever the device is turned ON with a battery installed.
- The green CHARGER ON indicator illuminates continuously whenever the unit is turned OFF and the installed battery has been fully charged to present capacity.
- The green and orange-yellow CHARGER ON indicators illuminate alternately when no battery is installed in the unit or when a battery charging fault has been detected.

When the device is not connected to AC mains, the CHARGER ON indicators remain extinguished. If your E Series unit does not function as expected, refer to the "Troubleshooting Guidelines" on page 13-1.

External Battery Charger

Use the ZOLL Base Power Charger 4x4 or ZOLL SurePower Charger for external battery charging and capacity evaluation. You can charge up to four battery packs simultaneously; testing is automatic. See the appropriate ZOLL battery charger operator's guide for more information.

Diagnostics

A computer contained within the unit performs self-diagnostic tests whenever the product is initially turned on and periodically during operation. During operation, a *Function* FAULT XX* message is displayed if a fault is detected. If this occurs, turn the unit off and then on and recheck operation. If the unit is connected to AC power, disconnect the power after turning the unit off, then reconnect and turn the unit on again. Contact authorized service personnel if the message continues to be displayed.

* *Function:* may include Recorder, Pacer, Defib, etc.



Safety Considerations

The E Series products are high energy devices capable of delivering up to 200 joules. To completely deactivate the device, you must turn the selector switch to the OFF position.

- In order to disarm a charged defibrillator, do one of the following: Turn the selector switch to **MONITOR, OFF** or **PACER** (pacer equipped versions only)
- Change the selected defibrillator energy

As a safety feature, the device automatically disarms if left charged for more than 60 seconds (15 seconds for AED versions).

WARNINGS - General

- Federal (U.S.A.) law restricts this device to use by or on the order of a physician.
- The use of external pacing/defibrillation electrodes or adapter devices from sources other than ZOLL is not recommended. ZOLL makes no representations or warranties regarding the performance or effectiveness of its products when used in conjunction with pacing/defibrillation electrodes or adapter devices from other sources. Device failures attributable to the use of pacing/defibrillation electrodes or adapters not manufactured by ZOLL may void ZOLL's warranty.
- Proper operation of the unit, together with correct electrode placement, is critical to obtaining optimal results. Operators must be thoroughly familiar with proper device operation.
- Do not use the unit in Semiautomatic mode during patient movement. A patient must be motionless during ECG analysis. Do not touch the patient during analysis. Cease all movement via stretcher or vehicle before analyzing the ECG. If using the device in an emergency vehicle, bring the vehicle to a halt before using in Semiautomatic mode.
- Place the patient on a firm surface before performing CPR.
- The device is protected against interference from radio frequency emissions typical of two-way radios and cellular phones (digital and analog) used in emergency service/public safety activities. Users should assess the device's performance in their typical environment of use for the possibility of radio frequency interference from high-power sources. Radio Frequency Interference (RFI) may be observed as shifts in monitor baseline, trace compression, display brightness changes or transient spikes on the display.
- E Series units equipped with the Bluetooth® option include an RF transmitter which transmits with 7dBm/5mW power in the 2.4 GHz ISM band.
- Do not operate the unit without a battery during patient care. Keep a fully charged spare battery pack with the device at all times.
- Regular use of partially charged battery packs without fully recharging between uses results in permanently reduced capacity and early battery pack failure.
- Test batteries regularly. Batteries that do not pass ZOLL's capacity test could unexpectedly shutdown without warning.
- Replace the battery with a fully charged battery immediately after the *LOW BATTERY* or *REPLACE BATTERY* message.
- Emergency defibrillation should be attempted only by appropriately trained, skilled personnel who are familiar with equipment operation. Training appropriateness, such as Advanced Cardiac Life Support (ACLS) or Basic Life Support (BLS) certification, should be determined by the prescribing physician.
- Synchronized cardioversion should only be attempted by skilled personnel trained in Advanced Cardiac Life Support (ACLS) and familiar with equipment operation. The precise cardiac arrhythmia must be determined before attempting defibrillation.
- Prior to attempting synchronized cardioversion, ensure that the ECG signal quality is good and that sync marks are displayed above each QRS complex.
- Pacing must be turned off before defibrillating with a second defibrillator. Otherwise, the E Series unit may be damaged.
- Carefully route the patient cables to avoid tripping over them.
- Carefully route the patient cables to avoid inadvertently pulling the unit onto the patient.
- Do not carry the unit while in use.
- These operating instructions describe the functions and proper operation of the E Series products. They are not intended as a substitute for a formal training course. Operators should obtain formal training from an appropriate authority prior to using the device for patient care.
- Do not disassemble the unit. A shock hazard exists. Refer all problems to authorized service personnel.

- The potential equalization connector on the rear connector panel of the device has no function during physiological monitoring or delivery of therapy.
- Follow all recommended maintenance instructions. If a problem occurs, obtain service immediately. Do not use the device until it has been inspected by the appropriate personnel.
- Do not use the unit's ECG out signal as a sync pulse for another defibrillator or cardioverter.
- To ensure patient safety, connect the ECG out jack and modem (if available) only to other equipment with galvanically-isolated circuits.
- The ECG out signal is delayed by up to 25 ms. This delay must be considered when the ECG out signal is used as an input to other devices requiring R-wave synchronization.
- The E Series device may not perform to specifications when stored at the upper or lower extreme limits of storage temperature and immediately put into use.
- Avoid using the E Series adjacent to, or stacked on, other equipment. If unavoidable, verify that the E Series operates normally in this configuration before clinical use.
- The E Series should be installed and put into service according to the Electromagnetic Compatibility (EMC) information in Appendix A of this manual.
- The use of accessories, transducers, and cables other than those specified in this manual and related E Series option manual inserts may result in increased emissions or decreased immunity of the E Series.



Operator Safety

- Do not use E Series products in the presence of oxygen-rich atmosphere, flammable anesthetics or other flammable agents (such as gasoline). Using the instrument near the site of a gasoline spill may cause an explosion.
- Do not use the instrument near or within puddles of water. Electrical safety of the device may be compromised when wet.
- Do not discharge the unit with paddles or MFE pads shorted together or in open air.
- Warn all persons in attendance of the patient to STAND CLEAR prior to defibrillator discharge.
- Do not touch the bed, patient, or any equipment connected to the patient during defibrillation. A severe shock can result. Do not allow exposed portions of the patient's body to come in contact with metal objects, such as a bed frame, as unwanted pathways for defibrillation current may result.
- Avoid contact with conductive fluids during defibrillation as unwanted current pathways may result.
- For defibrillation using paddles, utilize only high conductivity electrolyte gel specified by the manufacturer for such use.
- To avoid risk of electrical shock, do not allow electrolyte gel to accumulate on hands or paddle handles.
- To avoid risk of electrical shock, do not touch the gelled area of the MFE Pads while pacing. When defibrillating with paddles, use your thumbs to operate the **SHOCK** buttons in order to avoid inadvertent operator shock. No portion of the hand should be near the paddle plates.
- Disconnect all electro-medical equipment that is not defibrillation-protected from the patient prior to defibrillation.
- Always check that the equipment functions properly and is in proper condition before use.
- Do not discharge the defibrillator except as indicated in the instructions. Do not discharge the defibrillator if the MFE Pads are not properly attached to the patient.
- Only use thumbs to depress the paddle **SHOCK** buttons. Failure to do so could result in the inadvertent depression of the energy select buttons, causing the defibrillator to disarm itself.
- When the unit is connected to an AC power source, turning the selector switch to OFF is not sufficient to disconnect AC power from the unit. Instead, disconnect the AC power cord to completely remove AC power from the unit.
- The use of accessory equipment not complying with the equivalent safety requirements of this equipment may lead to a reduced level of safety of the resulting system. Consideration relating to the choice shall include:
 - Use of the accessory in the patient vicinity
 - Evidence that the safety certification of the accessory has been performed in accordance with the appropriate IEC (EN) 60601-1-1 harmonized national standards.



Patient Safety

- The use of the E Series Defibrillator is restricted to one patient at a time.

- The AutoPulse Plus is only intended for use on adults 18 years of age or older. When using the E Series and AutoPulse Plus as a system, this age restriction applies to the E Series as well.
- Carefully route the patient cables to reduce the possibility of patient entanglement or strangulation.
- Do not use the unit's AED function on patients under 8 years of age.
- Neonatal and pediatric defibrillation energy levels should be set based on site-specific clinical protocols.
- The device detects ECG electrical signals only. It will not detect a pulse (i.e. effective circulatory perfusion). Always verify pulse and heart rate by physical assessment of the patient. Never assume that a non-zero heart rate display means that the patient has a pulse.
- Implanted pacemakers may cause the heart rate meter to count the pacemaker rate during incidents of cardiac arrest or other arrhythmias. Pacemaker patients should be carefully observed. Check the patient's pulse; do not rely solely on heart rate meters. Dedicated pacemaker detection circuitry may not detect all implanted pacemaker spikes. Patient history and physical exam are important in determining the presence of an implanted pacemaker.
- Use only high quality ECG electrodes. ECG electrodes are for rhythm acquisition only. Do not attempt to defibrillate or pace through ECG electrodes.
- This equipment is suitable for use in the presence of electrosurgery.
- To avoid electrosurgery burns at monitoring sites, ensure proper connection of the electrosurgery return circuits so that the return paths cannot be made through monitoring electrodes or probes.
Do not use ECG electrodes or MFE Pads if the gel is dried, separated, torn, or split from the foil; patient burns may result from using such electrodes. Poor adherence and/or air under the MFE Pads can lead to the possibility of arcing and skin burns.
- The ECG rhythm analysis function does not warn the operator of patient asystole, as it is not a shockable rhythm.
- Excessive body hair or wet, diaphoretic skin can inhibit good coupling (contact), which can lead to the possibility of arcing and skin burns. Clip excess hair and dry surrounding moisture from the area where the electrode is to be attached. MFE Pads should be replaced after 8 hours of continuous pacing (2 hours for Radiolucent stat-padz) to ensure maximum patient benefit.
- Prolonged pacing (in excess of 30 minutes), particularly in neonates or adults with severely restricted blood flow, may cause burns. Periodically inspect the underlying skin.
- Check leakage levels prior to use. Leakage current may be excessive if more than one monitor or other piece of equipment is connected to the patient.
- Do not simultaneously touch the patient and battery pins on the unit.
- Do not simultaneously touch the patient and non-medical electrical equipment connected to the unit.



CAUTIONS

- Do not install the battery into the device when storage may exceed 90 days. Battery damage may occur.
- The *LOW BATTERY* message display-to-shutdown interval may be less than one minute when older batteries become depleted.
- Do not sterilize the device.
- Do not sterilize the CPRD-to-MFC connector.
- Do not immerse any part of the device in water.
- Do not use alcohol or ketones (MEK, acetone, etc.) on the device.
- Avoid using abrasives (e.g. paper towels) on the display window.
- Grounding reliability can only be certain when the equipment is connected to an equivalent receptacle marked HOSPITAL ONLY or HOSPITAL GRADE. If the grounding integrity of the line cord or AC receptacle is in doubt, operate on battery only.
- Multiple portable socket-outlets or extension cords should not be connected to the unit.
- Do not use accessories not specified for use with the E Series units.
- Use only ECG cables (namely, ones with internal current-limiting resistors) specified or supplied by ZOLL Medical Corporation to protect the E Series from damage during defibrillation, for accurate ECG information, and for protection against noise and other interference.

FCC Statement Regarding Bluetooth Operation

This device complies with Part 15 of FCC Rules. Operation is subject to the following two conditions: (1) this device may not cause harmful interference, and (2) this device must accept any interference received, including interference that may cause undesired operation.

Bluetooth equipped E Series units may contain FCC ID: PVH070101 or FCC ID: PVH090202S.

Restarting the Device

Certain events require the E Series products to be restarted after they shut off or become inoperative.

One example is when the battery runs down and the unit shuts off. In this case, perform these steps in this order:

1. Turn the selector switch to the OFF position
2. Remove the battery.
3. Insert a new battery.
4. Turn the selector switch to the desired operating mode to resume operation.

This sequence is necessary to restart the device, and can also be used to clear some *X FAULT XX* messages, when immediate use of the device is required.

Note that some settings (for example, alarm settings, lead selection, ECG size) may need to be restored from their default values when operation is resumed.

FDA Regulations

Tracking Requirements

U.S. Federal Law (21 CFR 821) requires the tracking of defibrillators. As an owner of this device, you have the responsibility under this law to notify ZOLL Medical Corporation if this product has been:

- received
- lost, stolen or destroyed
- donated, resold, or otherwise distributed to a different organization.

If any of the events described above occur, please contact ZOLL Medical Corporation in writing with the following information:

1. Originator's organization — Company Name, Address, Contact Name, and Contact Phone Number
2. Model Number and Serial Number
3. Disposition of Device (e.g., received, lost, stolen, destroyed, distributed to another organization), New Location and/or Organization (if known and different from #1 above) — Company Name, Address, Contact Name, and Contact Phone Number
4. Date change took effect
5. Other information or comments

Please address your information to:

ZOLL Medical Corporation
Attn: Tracking Coordinator
269 Mill Road
Chelmsford, MA 01824-4105

Fax: (978) 421-0010

Tel: (978) 421-9655

Notification of Adverse Events

Under the Safe Medical Devices Act (SMDA), health care providers are responsible for reporting to ZOLL, and possibly to the FDA, the occurrence of certain events.

These events, described in 21 CFR Part 803, include device related death and serious injury or illness. In any event, as part of our Quality Assurance Program, ZOLL should be notified of any device failures or malfunctions. This information is required to assure that ZOLL provides only the highest quality products.

Software License

Note: Read this Operator's Manual and License agreement carefully before operating any of the E Series products.

Software incorporated into the system is protected by copyright laws and international copyright treaties as well as other intellectual property laws and treaties. This software is licensed, not sold. By taking delivery of and using this system, the Purchaser signifies agreement to and acceptance of the following terms and conditions:

1. **Grant of License:** In consideration of payment of the software license fee which is part of the price paid for this product, ZOLL Medical Corporation grants the Purchaser a non-exclusive license, without right to sublicense, to use the system software in object-code form only.
2. **Ownership of Software/Firmware:** Title to, ownership of and all rights and interests in the system software and all copies thereof remain at all times vested in the manufacturer and Licensors to ZOLL Medical Corporation and they do not pass to Purchaser.
3. **Assignment:** Purchaser agrees not to assign, sublicense or otherwise transfer or share its rights under the license without the express written permission of ZOLL Medical Corporation.
4. **Use Restrictions:** As the Purchaser, you may physically transfer the products from one location to another provided that the software/firmware is not copied. You may not disclose, publish, translate, release, or distribute copies of the software/firmware to others. You may not modify, adapt, translate, reverse engineer, decompile, crosscompile, disassemble, or create derivative works based on the software/firmware.

Service

The device does not require periodic recalibration or adjustment. Appropriately trained and qualified personnel should, however, perform periodic tests of the device to verify proper operation. (See "General Maintenance" on page 11-1).

Returning a unit for service

Before sending a unit to the ZOLL Technical Service Department for repair, obtain a service request (SR) number from the service representative.

Remove the battery pack from the unit, and pack the unit with its cables in the original containers (if available) or equivalent packaging. Be sure the assigned service request number appears on each package.

For customers	Return the unit to
In the U.S.A.	ZOLL Medical Corporation 269 Mill Road Chelmsford, MA 01824-4105 Attention: Technical Service Department (<i>SR number</i>) Telephone: 1-800-348-9011
In Canada	ZOLL Medical Canada Inc. 1750 Sismet Road, Unit #1 Mississauga, ON L4W 1R6 Attention: Technical Service Department (<i>SR number</i>) Telephone: 1-866-442-1011
In other locations	The nearest authorized ZOLL Medical Corporation representative. To locate an authorized service center, contact the International Sales Department at ZOLL Medical Corporation 269 Mill Road Chelmsford, MA 01824-4105 Telephone: 1-978-421-9655

The ZOLL Serial Number

Each ZOLL product displays a serial number that contains information about that product. From left to right, ZOLL serial numbers are structured as follows:

- A two-character product code
- A three-character date-of-manufacture code
- A product serial number of six or more alphanumeric characters

The product code for the E Series defibrillator is AB.

The first two characters of the date-of-manufacture code give the last two digits of the year (for example, "06" would appear for products manufactured in 2006). The last character of the date-of-manufacture code gives the month in which the product was manufactured. The month appears in the form of a single alphanumeric character: "A" for January, "B" for February, "C" for March, and so on through "L" for December.

The product serial number is a unique set of alphanumeric characters that ZOLL assigns to an individual unit.

SECTION 2

OPERATING CONTROLS AND INDICATORS

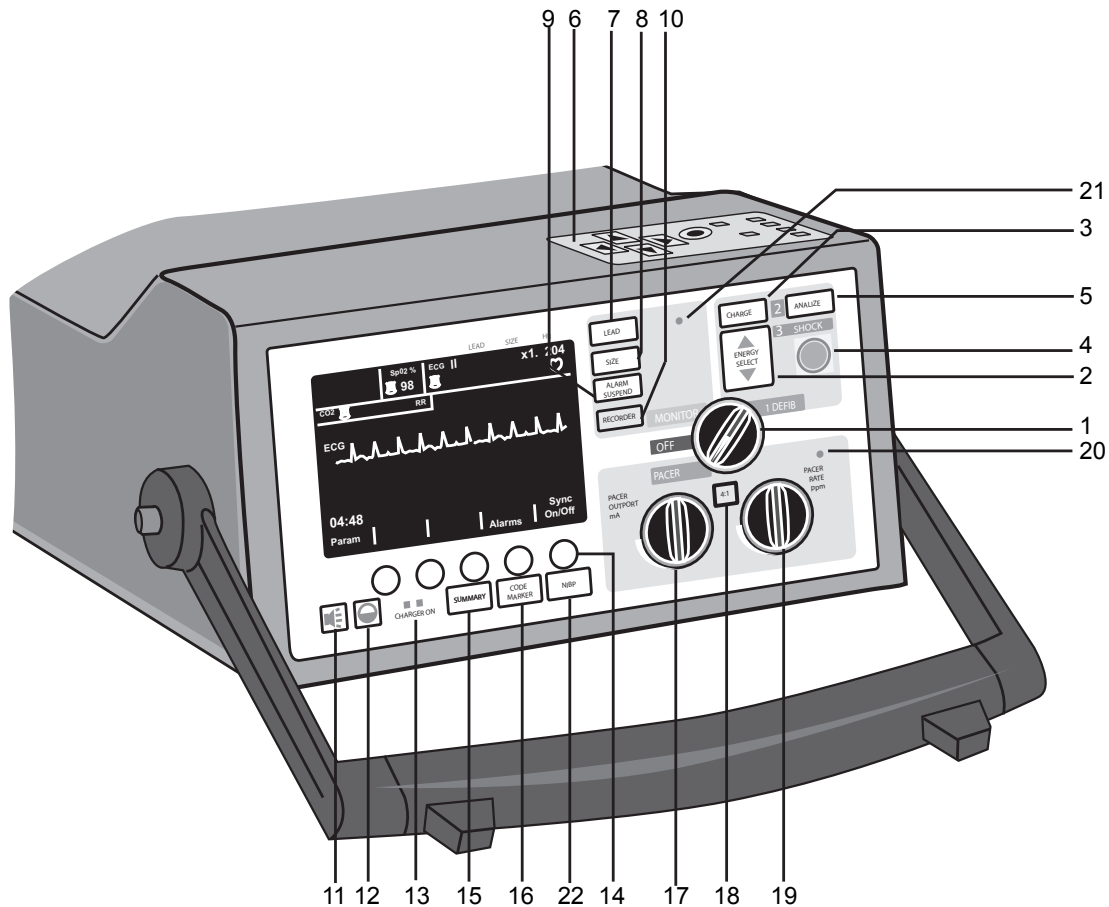

1. Selector Switch

Allows selection of **OFF**, **MONITOR**, **DEFIB**, and **PACER**, (Pacer version only) modes.

2. ENERGY SELECT Buttons

Allows selection of defibrillation energy level. There are two sets of up-down arrow buttons; one set located on the front panel and the other (not shown) located on the sternum paddle. Press and hold the up or down arrow button until the desired energy level is indicated on the display.

3. CHARGE Button

Pressing the **CHARGE** button on the front panel or, if using paddles, on the apex paddle handle (not shown), charges the defibrillator to the selected energy level.

4. SHOCK Button

The **SHOCK** button illuminates when the defibrillator is charged and ready. Press and hold the button to discharge the defibrillator.

The **SHOCK** button is active only when using MFE Pads. The **SHOCK** button is not functional when external paddles are connected to the unit.

Each external paddle has a **SHOCK** button located near the forward end of the handle. Press and hold both buttons simultaneously to discharge the defibrillator.

5. ANALYZE Button

Initiates ECG analysis to identify shockable rhythms.

6. Scroll Keys and Commit Key

Scroll keys (with arrows) located on top of the unit control cursor movement for data entry in select software screens. The Commit key (circular) allows you to save selected or entered data to a field.

7. LEAD Button

Determines selection of the ECG source. Pressing this button sequentially selects ECG signals derived from each of the following lead configurations — I, II, III, aVR, aVF, aVL, PADDLES (defibrillator paddles), or PADS (MFE pads) for display. The PADS or PADDLES lead setting is automatically selected when the instrument powers up in DEFIB or MONITOR mode and MFE Pads or Paddles are connected to the Multi-Function cable.



Lead II is automatically selected when the E Series unit powers up in PACER mode (Pacer version only). Pads or Paddles monitoring is not available in PACER mode.

“APLS” will be displayed in the upper right-hand corner of the display if the unit is connected to PADS through an AutoPulse Plus.

8. SIZE Button

Allows you to change the display size of the ECG signal. Size options are 0.5, 1, 1.5, 2, 3 cm/mV and are indicated in the upper right of the display.

9. ALARM SUSPEND Button

Turns the audible alarm indicators on and off. An alarm symbol () appears in the top-center of the display when the alarms are enabled. When the alarms are entirely disabled, or the audible alarm indicators are off, the alarm symbol is crossed out (.

When alarms are enabled, and an alarm condition occurs, a tone sounds and the alarm symbol flashes. To avoid possible confusion with the defibrillator charged tone, the heart rate alarm sounds at a different frequency when the Selector Switch is set to DEFIB.

10. RECORDER Buttons

Located on the unit's front panel and another located on the sternum paddle (not shown), starts and stops the stripchart recorder.

Pressing and holding the **RECORDER** button switches the unit to diagnostic ECG bandwidth (0.05-150 Hz).

Diagnostic bandwidth is maintained as long as the **RECORDER** button is held down. The unit reverts to standard monitoring bandwidth when the **RECORDER** button is released.

11. VOLUME Button (for ECG tone and voice prompts only)

Allows for manual adjustment of the QRS beeper tone from maximum volume to inaudible, and voice prompts from maximum volume to minimum volume. (The heart rate alarm and charge ready volumes are not adjustable.) Press this button to display a menu for adjusting the volume using softkeys.

12. CONTRAST Button

Brings up a menu on the display for adjusting the display brightness (contrast on LCD) using softkeys.

Press and hold this button to disable color settings and select between two contrast settings: black on white background or white on black background.

13. CHARGER ON Indicators

When the E Series unit is plugged into AC mains, the CHARGER ON indicators operate as described previously in “Internal Battery Charging” on page 1-10.

When the device is not connected to AC mains, the CHARGER ON indicators remain extinguished.

14. Softkeys

Five unlabeled buttons located directly beneath the display control different functions depending on the current operating mode of the unit. Softkey labels appear at the bottom of the display directly above each softkey to indicate its function.

15. SUMMARY Button

Retrieves stored patient information and prints it on the unit recorder as a summary report. The summary report function automatically collects critical patient ECG data, control settings, date, time and therapies administered during certain events. See “Summary Report Function” on page 2-4 for more information.

16. CODE MARKER Button

Activates a menu and allows the unit to record in its internal memory the delivery of specific drugs or treatments.

See “Code Markers” on page 2-4 for more information.

17. Pacer Output mA (Pacer Version Only)

When pacing is selected, this control sets the amount of current delivered to the MFE Pads. For conscious patients, it should be gradually increased until capture is recognized. The selected current setting is indicated on the display.

18. 4:1 BUTTON (Pacer Version Only)

Tests for threshold or to determine the patient's underlying rhythm. When depressed, this button causes pacing stimuli to be delivered at ¼ of the frequency of the current ppm setting. The device resumes normal pacing operation when the button is released.

19. Pacer Rate ppm (Pacer Version Only)

When pacing is selected, this control sets the rate at which the pacemaker will operate. It must be set above the patient's intrinsic rate in order for the pacemaker to provide stimulation. The selected pace rate setting is indicated on the display.

20. Systole and Alarm Speaker

Emits an audible heart rate tone during ECG monitoring, and audible alarm indications when an alarm condition occurs.

21. Microphone (Optional)

Records audio activity in the vicinity of the E Series unit for storage on the PCMCIA data card.

22. NIBP Button (Optional)

Allows you to start single, auto, or STAT noninvasive blood pressure measurements as described in the option insert *Non-Invasive Blood Pressure* (part number 9650-1214-01). Your unit has this button only if you ordered this configuration.

The next three items are located on the top of all units, as shown in the following figure.

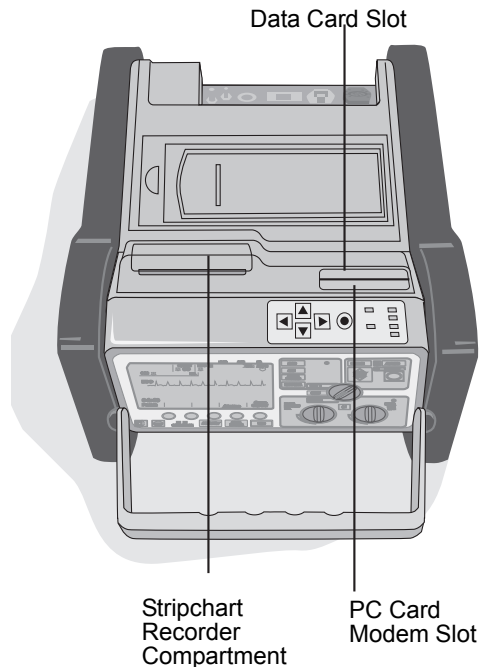

Stripchart Recorder Compartment

Located on top of the unit, the recorder compartment holds the paper supply for the recorder. Open the cover to replace the paper.

PCMCIA Data Card Slot

Located on top of the unit, the PCMCIA data card slot holds the PCMCIA flash memory card for data storage and retrieval.

PC Card Modem Slot (12-Lead Option Only)

Located on top of the unit, the PC Card modem slot holds the modem card for transmitting 12-Lead ECG information to remote locations via landline or cellular phone. See the *12-Lead ECG Monitoring* insert (part number 9650-1213-01) for more information.

Charge Indicator Light (Not Shown)

Located on the apex paddle, this light turns on when the defibrillator is charged and ready.

Defibrillator Test Port (Not Shown)

Located on the Multi-Function Cable, the test connector is used to test the defibrillator output using the Multi-Function Cable only.

Pediatric Paddles

Pediatric-size electrodes are built into the paddle assembly; they lie directly under the adult electrode surface. Access them by pushing the black **PEDI** button at the front of each paddle and sliding the adult surface forward. When replacing the adult electrodes, it is

important that the electrode is locked correctly in position on the paddle handle.

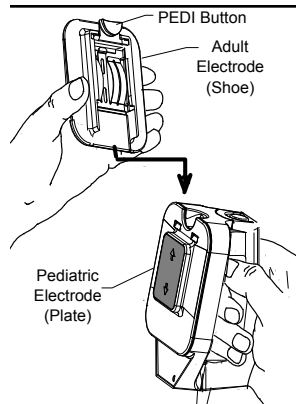

Volt ECG Out (Not Shown)

A 1 volt/cm of displayed ECG signal output is available from a subminiature phone jack located on the back of the device. This output may be used for interconnections to patient monitors and radio-telemetry equipment. The tip carries the ECG signal and the sleeve is ground.

Code Markers

When you press the **CODE MARKER** button on the front panel, the unit displays a preconfigured list of clinical actions. See the *E Series Configuration Guide* (part number 9650-1201-01) for information on configuring code markers.

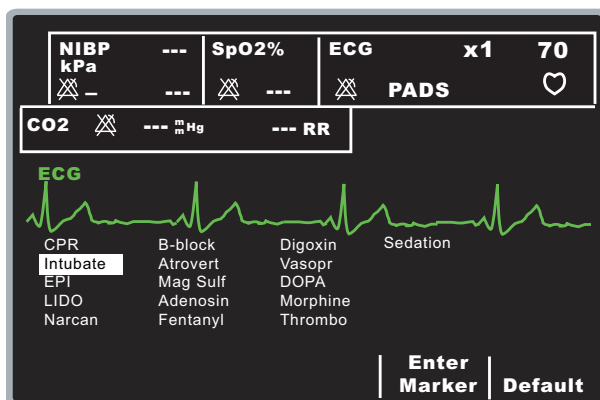

Use the scroll keys on top of the unit to scroll through the list of available clinical actions, then press the **Commit** (⊙) key on top of the unit, or the **Enter Marker** softkey, to record the action, along with a date and time stamp, in Summary Report memory.

In addition, the Protocol Assist Code Markers™ feature facilitates code marker entry by retaining the last code marker selection in memory. When you open the Code Marker menu, the cursor automatically highlights the next item in the list after the most recently selected item. If the list of code markers has been configured in order of medical protocol, you can quickly enter the highlighted

clinical action without having to scroll through the list. If no code marker has been entered, the cursor highlights the first item in the list.

Note: Selecting code markers out of order disables this feature.

Separate Code Marker lists are maintained for PACER, MONITOR, and DEFIB modes thereby enabling the appropriate Code Markers to be displayed for the particular protocol.

The Code Markers are removed from the display after 10 seconds. If no **Code Marker** softkey has been pressed in that time, a generic event mark is stored in Summary Report memory.

Summary Report Function

The summary report function allows you to store and later retrieve important ECG and device event information. The unit's internal memory automatically records defibrillation and cardioversion segments, PACER mode (Pacer version only), heart rate alarm and ECG segments upon activation of the strip chart recorder. Associated event information including device control settings, patient ECG, time and date are recorded as well.

Note: Diagnostic bandwidth recordings are not included in the summary report function.

Summary Report records each event in chronological order and stores up to 250 defibrillation or 210 recorder activated ECG events. All event data remains in memory and is accessible until data is manually erased or until the pre-configured time interval has elapsed, as specified in the "Set Report Restart Delay" parameter. See the *E Series Configuration Guide* (part number 9650-1201-01) for more information.

Summary Report is user configurable for automatic erasure after power off detection, with selection values of 5, 15, 30 and 90 minutes, 6, 12, and 18 hours, and 1.5 days. Summary Report can also be erased manually at any time. When Summary Report memory becomes full, a **REPORT FULL** message is displayed and no further records are stored.

You can also select "Erase All" from the Summary Erase menu. Doing so erases Summary Report, Patient Records and Trend collectively.

A summary report may be printed by pressing the **SUMMARY** button on the front panel.

Summary Report Formats

The summary report function prints an overview of all the events currently stored in memory including total number of defibrillation shocks delivered, total pacing time (cumulative), time and date the device was turned on (or if you have just manually erased summary reports, then start time and date of the next report), time of last event,

as well as space for patient name, date and comments. On the last event recorded, "SUMMARY COMPLETE" is printed at the bottom left of the recorder strip.

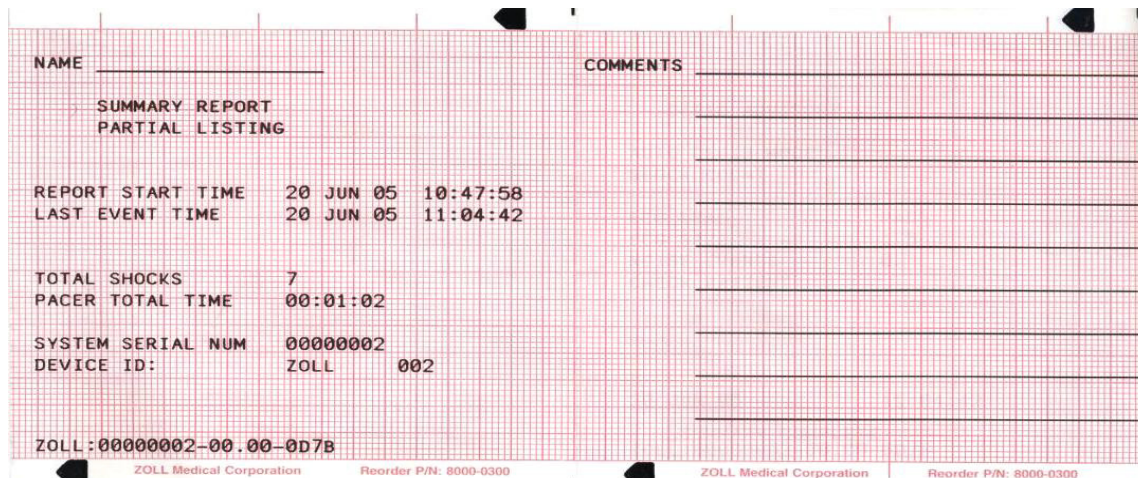

Defibrillation Format

The summary report function records 6 seconds of pre-shock and 9 seconds of post-shock patient ECG data. Also recorded are joules selected, joules delivered, sync if active (includes sync markers), ECG lead, ECG size, patient impedance, actual event time and date. The date/time printed on the top of the strip corresponds to the ECG data occurring 6 seconds before the event. AED units additionally include shock count and AED mode annotations.

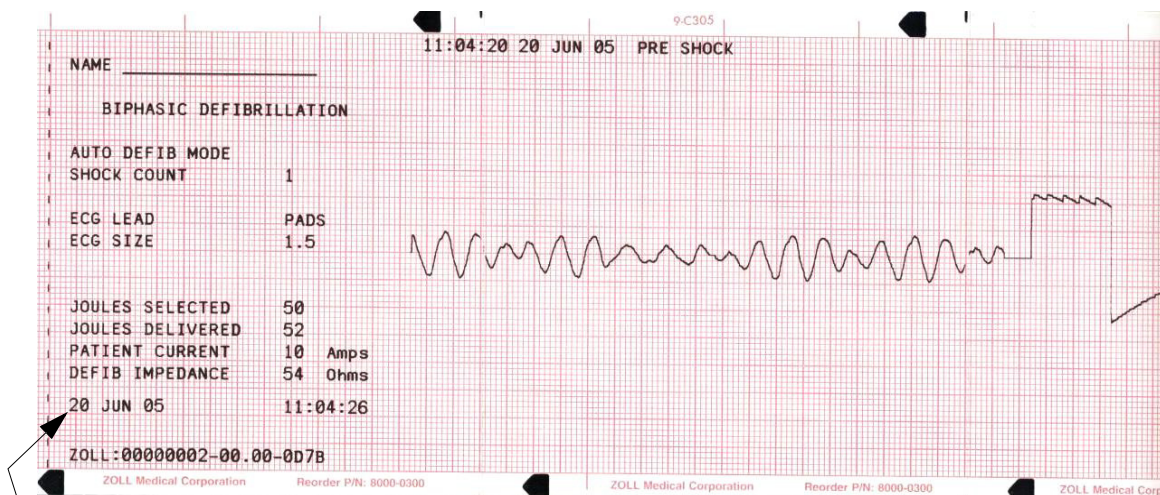

Actual event date/time

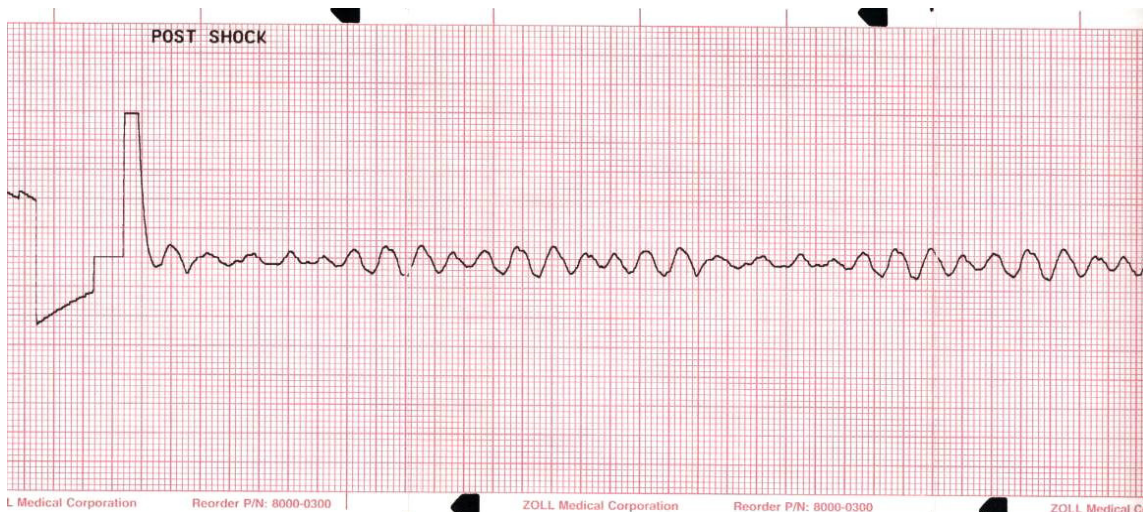

Pacer Format (Pacer version only)

The summary report function records 6 seconds of pre-pacer patient ECG data. Also recorded are the ECG lead, ECG size, patient's heart rate, actual event time and date. The date/time printed on the top of the strip corresponds to the ECG data occurring 6 seconds before the event.

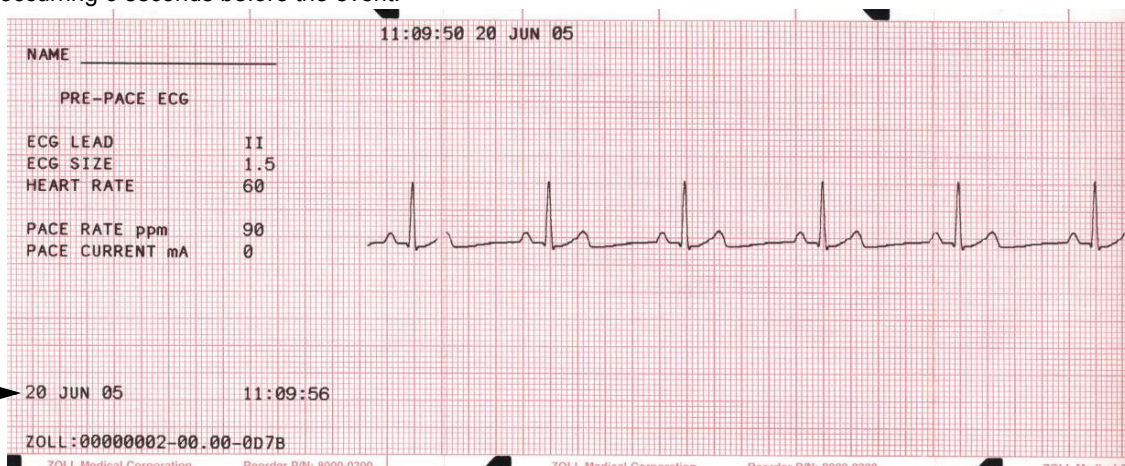

After establishing a paced rhythm, turning the recorder on briefly records the paced rhythm for later reports. If async pace is active, the annotation "ASYNC PACE" is also recorded and printed.

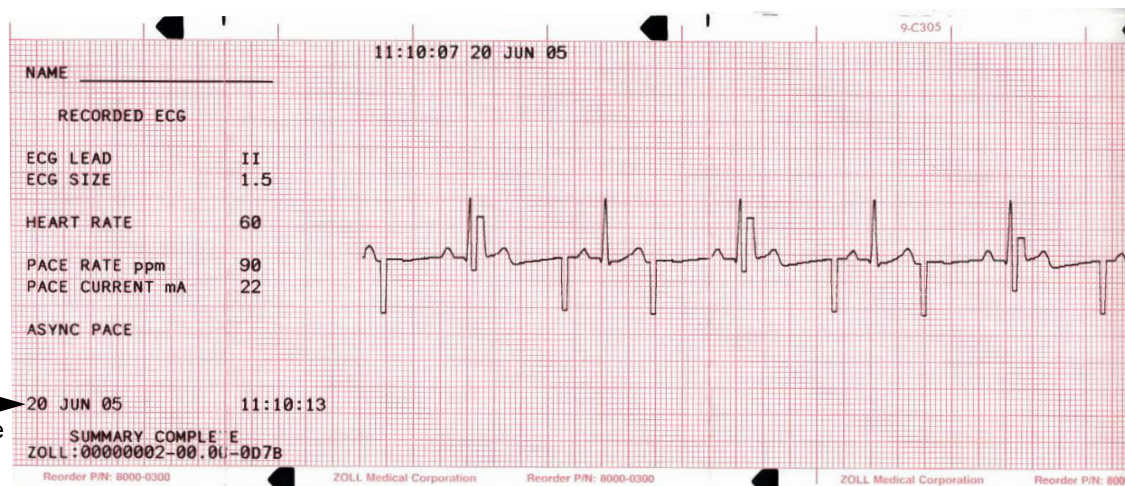

Heart Rate Alarm Activated Format

The summary report function records 6 seconds of pre-alarm patient ECG. Also recorded are the ECG lead, ECG size, patient's heart rate, actual event time, and date. The date/time printed on the top of the strip corresponds to the ECG data occurring 6 seconds before the event. If the pacer is on during this event, the pacing rate and pacing current are also recorded.

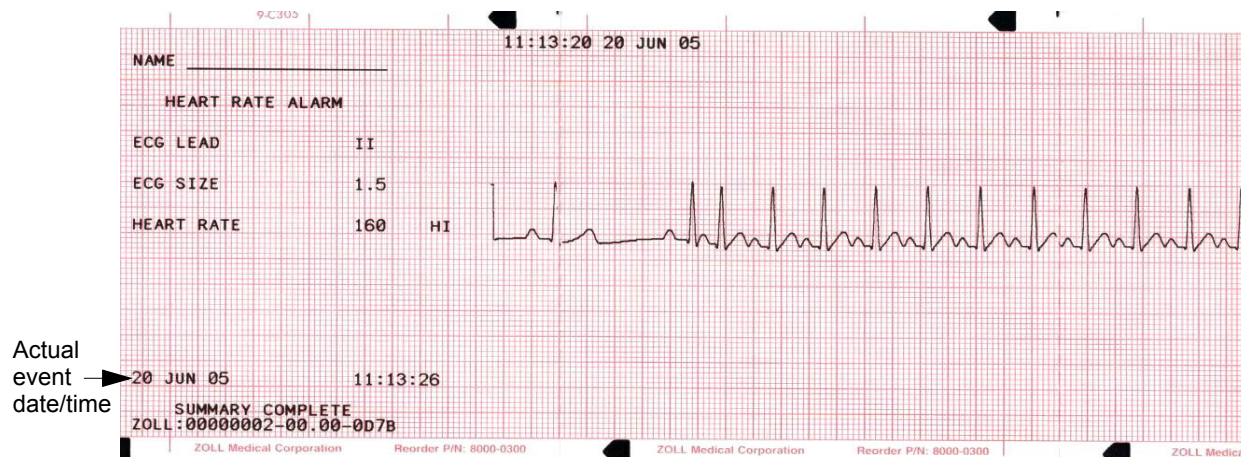

VF Alarm Activated Format (Refer to Section 6)

The summary report function records 18 seconds of patient ECG data associated with each VF alarm. Also recorded are the shock count, ECG lead, ECG size, actual event time, patient's heart rate, and noise events. The date/time printed on the top of the strip corresponds to the ECG data occurring 6 seconds before the event.

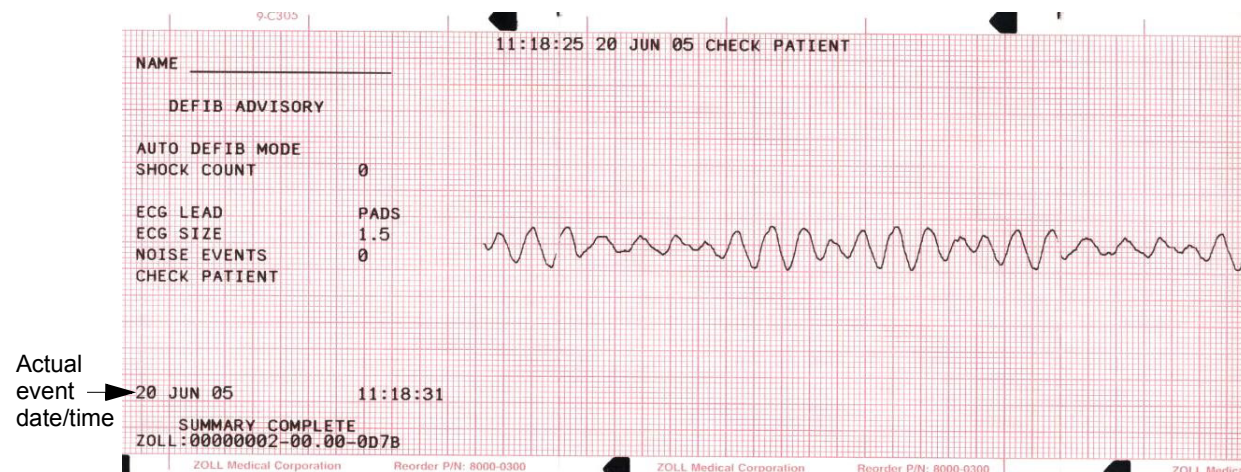

Recorder On Format

The summary report function records 6 seconds of patient ECG prior to turning on the recorder. Also recorded are the ECG lead, ECG size, patient's heart rate, actual event time, and date. The date/time printed on the top of the strip corresponds to the ECG data occurring 6 seconds before the event. If the pacer is on during this event, the pacing rate

and pacing current are also recorded. If async pace is active, the annotation "ASYNC PACE" is recorded. AED units additionally include shock count and AED mode annotations.

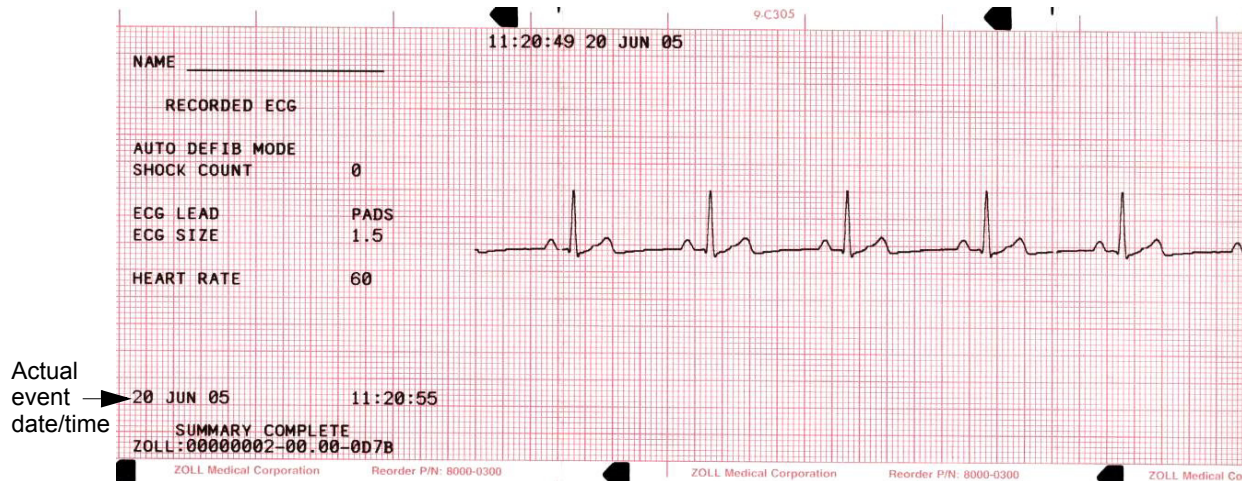

Analyze Format

The summary report function records six seconds of pre analysis ECG and 12 seconds of ECG recorded during the ECG analysis interval with the annotation "SHOCK ADVISED" or "NO SHOCK ADVISED." AED units additionally include shock count and AED mode annotations. The date/time printed on the top of the strip corresponds to the ECG data occurring 6 seconds before the event.

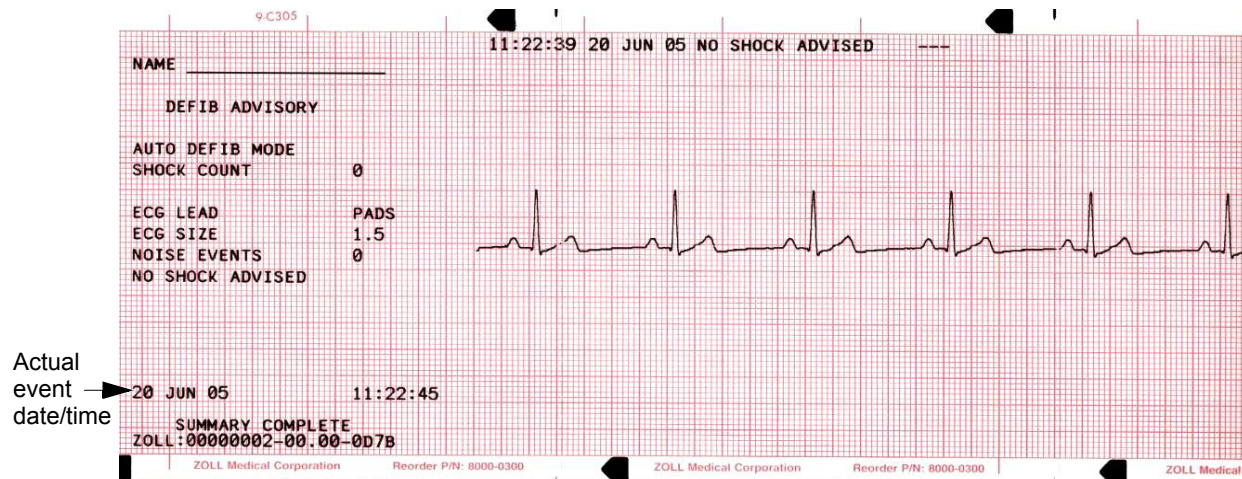

The following annotations may also appear at the top of the Analyze Format printout:

Annotation	Description
POOR PAD CONTACT	The MFE Pads are detected as having poor connection.
ANALYSIS HALTED	The ECG analysis is halted due to either the ANALYZE button being pushed or a fault condition.
NOISY ECG	Excessive noise is detected.
SHOCK ADVISED	Shockable rhythm has been detected at the end of user-initiated ECG analysis.
NO SHOCK ADVISED	No shockable rhythm has been detected at the end of user-initiated ECG analysis.
ECG TOO LARGE	The amplitude of the ECG signal is too large for proper rhythm analysis.

Manual Mode Activated

AED versions of the E Series will record a “MANUAL MODE STARTED” summary report event when the device is switched from Semiautomatic mode to Manual mode.

Printing a Report

To print the stored information, press the **SUMMARY** button below the screen display. Then press the corresponding softkey to print a “call” report, summary report (print chart), or incident log.

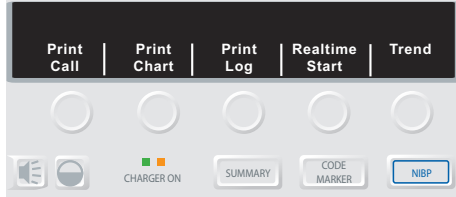

The recorder prints all summary report events currently in memory in chronological order. If the unit is equipped with the 12-lead option, the recorder will print all 12-lead patient records currently in memory at the end of the summary report printout. If the stripchart recorder is on or the defibrillator is charged, summary report printing is disabled. In addition:

- To stop printing a report, press the **RECORDER** button or turn the unit off. You can print an unlimited number of copies of the report by pressing the **SUMMARY** button and corresponding print softkey again.
- If you press the **RECORDER** button while printing a summary report, the unit stops printing the report. Press the **RECORDER** button again to begin printing an ECG trace. The stripchart recorder runs continuously until the button is pressed again.
- If you press the **SUMMARY** button and a corresponding print softkey while a report is already printing, the current report stops printing and a new report begins to print.
- Printing is interrupted if a vital sign alarm occurs (i.e. HR, SpO2, etc.), the **ANALYZE** button is pressed, or the defibrillator is charged.
- If the recorder is out of paper when the **SUMMARY** button and a corresponding print softkey are pressed, a *CHECK RECORDER* message appears on the display. Load paper and press the **SUMMARY** button again to select the report to print.

Printing a Call Report

A Call Report is an abbreviated summary report containing only those events associated with a specific call or run. To print a call report:

1. Press the **SUMMARY** button.
2. Press the **Print Call** softkey.

3. Use the scroll keys on top of the unit to scroll through the list of start times associated with different calls.

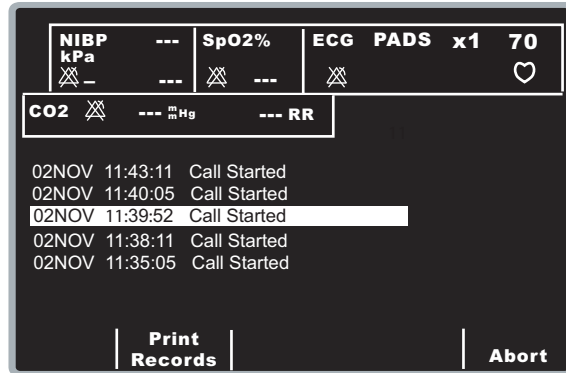

4. Press the **Commit** (⊙) key on top of the unit, or the **Print Records** softkey, to print the events associated with the selected call.

Printing a Partial Summary Report

To print only a portion of the Summary Report:

1. Press the **SUMMARY** button.
2. Press the **Print Chart** softkey.
3. Press the **Print Range** softkey.
4. Use the scroll keys on top of the unit to scroll through the list of events.

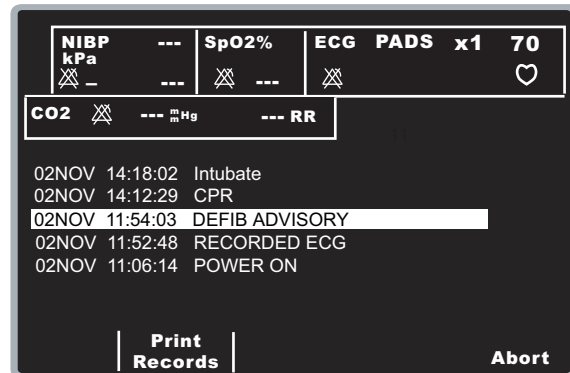

5. Press the **Commit** (⊙) key on top of the unit, or the **Print Records** softkey, to print the specified event and all subsequent events.

Printing an Incident Log

An incident log is an abbreviated list of all major events recorded in the summary report. You can print out an incident log that includes the time of occurrence of the following events:

- E Series unit powered on
- Defibrillation advisory messages (for example, *CHECK PATIENT* and *SHOCK ADVISED*)
- Defibrillation shocks (including energy level)
- Pacer mode activated

- Manual mode started (AED only)
- Alarms triggered
- Code markers
- Recorder turned on
- NIBP measurements activated (if option is included)

In addition, the incident log lists the following:

- Report start time (time when Summary Report memory was erased)
- Last event time (time of last event in memory)
- Total number of shocks
- Total pacer time
- System serial number
- Device identification number

Finally, a 12-lead log (if applicable) is appended to the end of the incident log.

To print an incident log:

1. Press the **SUMMARY** button.
2. Press the **Print Log** softkey.

Adding a Patient Name and ID Number to a Report

To add patient name and identification number to the summary report:

1. Press the **ID #** softkey to access the Name and ID# screen.
The cursor goes directly to Patient Name field. If you don't want to enter a name, press the **ID #** softkey to move the cursor to the Patient ID field.
2. Use the scroll keys on top of the unit to select a character on the keypad, then press the **Commit** (⊙) key on top of the unit to enter the character in the Patient Name field.



Space Bar

Repeat until you have entered the patient's entire name (up to 14 characters).

3. When you have entered the patient name, you can do one of the following things:

- Select the **Enter** (↵) key from the keypad and press the **Commit** (⊙) key on top of the unit. The highlight automatically advances to the Patient ID# line.

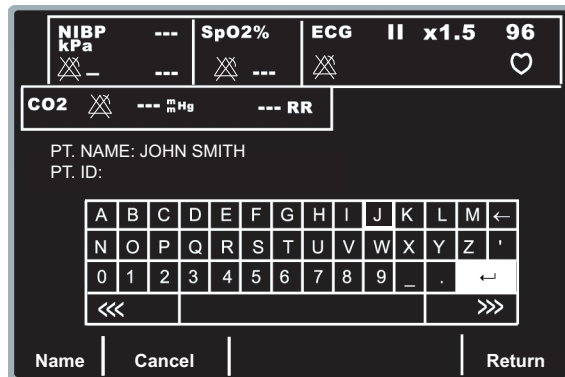

- Press the **ID #** softkey to advance to the Patient ID field.
- Press the **Return** Softkey to save the information, if you do not want to enter a Patient ID number. This returns you to the main menu.

Pressing the **Cancel** softkey returns you to the Patient Information menu without storing the name and ID number.

4. Repeat step 2 to enter up to 14 characters in the Patient ID field.



5. When you have entered the ID#, you can do one of the following things:
 - Select the **Enter** (↵) key from the keypad and press the **Commit** (⊙) key on top of the unit to store the name and ID number and return to the Patient Information menu.
 - Press the **Return** Softkey to store the name and ID number and return to the Patient Information menu.
 - Press the **Name** softkey to go back to the name field to make any corrections to the name field.

Pressing the **Cancel** softkey returns you to the Patient Information menu without storing the name and ID number.

Note: You cannot add a patient name to summary report events already stored in memory. The patient name is stored only with those summary events saved after the patient name has been entered.

Modifying a Patient Name and ID Number

To change an existing patient name and identification number:

1. Press **ID #** softkey to display the Patient Name and ID screen and keypad.
2. Use the scroll keys on top of the unit to select the **Next** key (>>>) or the **Prev** key (<<<) on the keypad, then press the **Commit** (⊙) key, as many times as necessary to move the cursor to the desired position.

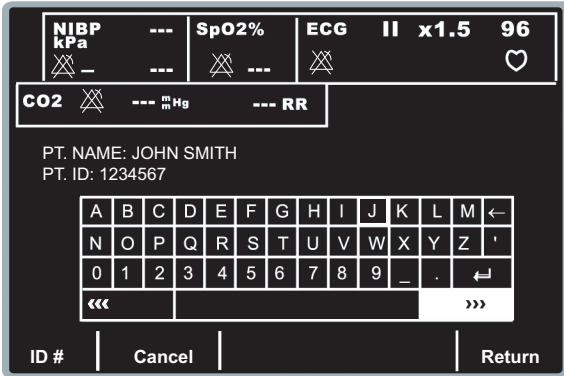

3. Use the scroll keys on top of the unit to select the **Backspace** key (←) on the keypad, then press the **Commit** (⊙) key to erase the selected character. Repeat as necessary

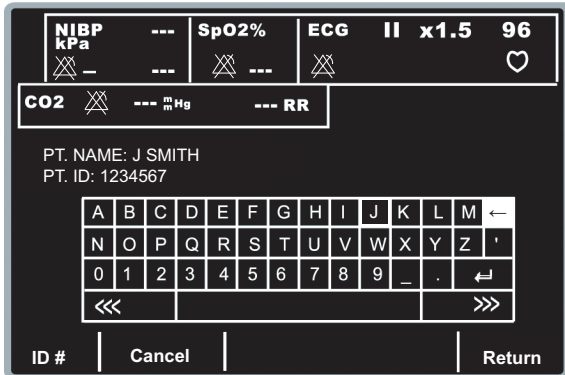

4. Enter the new characters in the Patient Name field, using the scroll keys on top of the unit to select characters from the keypad and pressing the **Commit** (⊙) key to enter the selection.

5. When you have modified the patient name, move the cursor to the **Enter** (↵) key on the keypad and press the **Commit** (⊙) key on top of the unit.

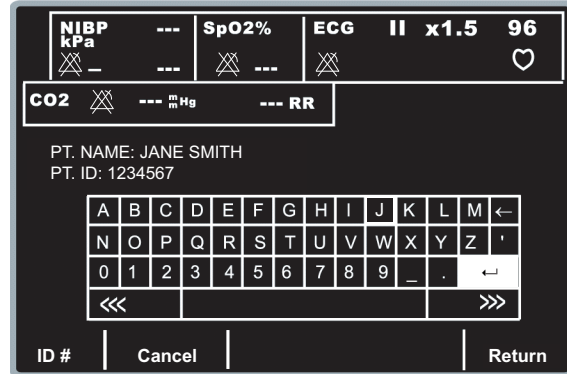

6. Repeat steps 2 through 5 to modify the Patient ID field. Otherwise, press the **Commit** (⊙) key again, with the **Enter** (↵) key highlighted (or press the **Return** softkey), to return to the main menu.

Erasing Summary Report Memory

To erase all stored information, press and hold the **SUMMARY** button for approximately 4 seconds. Then press the corresponding softkey to erase summary, erase trend, or erase all event reports. An *ERASING REPORT* message appears on the display.



Turning the unit off for more than 15 minutes, unless configured otherwise, also erases summary and trend report memory. All events remain stored until you erase them or the unit has been turned off for a user-configurable time period of 5 minutes to 36 hours.

(This page intentionally left blank.)

SECTION 3

MANUAL DEFIBRILLATION



Paddles/pads are a defibrillation-protected Type BF patient connection.



ECG leads are a defibrillation-protected Type CF patient connection.

Emergency Defibrillation Procedure with Paddles or MFE Pads

WARNING

- To avoid risk of electrical shock, do not allow electrolyte gel to accumulate on hands or paddle handles.
- When defibrillating with paddles, use your thumbs to operate the **SHOCK** buttons in order to avoid operator shock. No portion of the hand should be near the paddle plates.
- The AutoPulse Plus is only intended for use on adults 18 years of age or older. When using the E Series and AutoPulse Plus as a system, this age restriction applies to the E Series as well.

You can perform manual defibrillation using either paddles or MFE pads; the manual defibrillation procedure described in this section allows for either.

Before you begin manual defibrillation:

- Determine the patient's condition following medical protocols and by verifying:
 - Unconsciousness
 - Absence of breathing, and
 - Absence of pulse
- If appropriate, begin CPR following medical protocol, and request additional assistance.

Note: If you are using MFE pads, prepare the patient and attach the MFE pads as described in "MFE Pad Application/Connection" on page 1-9.

If connecting to PADS through the AutoPulse Plus, refer to the *User Guide AutoPulse® Resuscitation System Model 100 with Defibrillator Interface* addendum (part number 9650-0720-01) for instructions on properly connecting the E Series to the AutoPulse Plus. It is recommended that the user cycle through the lead setting until the APLS icon appears in the upper right-hand corner of the display, indicating that the unit recognizes the connection to the AutoPulse Plus.

WARNING

If the APLS icon does not appear, check that the E Series and AutoPulse Plus are properly connected. If the APLS icon still does not appear, or a PADDLE FAULT occurs, discharge energy internally by changing the energy selection, disconnect the Multi-Function Cable and PADS from the AutoPulse Plus, and connect the Multi-Function Cable directly to the PADS.

1 Prepare the unit for defibrillation.

Turn the unit to DEFIB.

The unit automatically defaults to 120 J or the first shock energy selection configured by the user. For information about configuring energy levels, refer to the *E Series Configuration Guide* (part number 9650-1201-01).

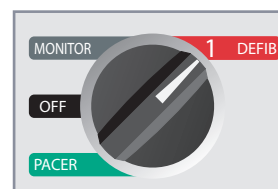

Note: When the unit is turned to MONITOR or DEFIB, the ECG source is set either to PADDLES (if paddles are connected to the Multi-Function cable), or to Multi-function pads (if paddles are not connected to the Multi-Function cable). If connected to the AutoPulse Plus, the APLS icon will be displayed and PADS will be the ECG lead source. You can select any of the other ECG lead configurations — I, II, III (also aVR, aVF, aVL, and V) if the unit has been so configured and ECG cable/electrodes are in use.

Energy Select

Observe the display and verify the selected energy is appropriate. To change the energy setting, use either pair of up-down arrow buttons.

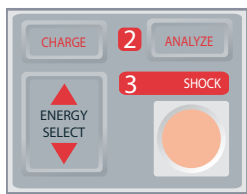

Energy Select on Front Panel

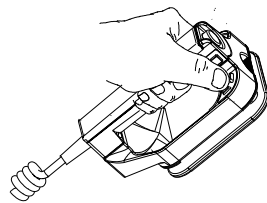

Energy Select on Sternum Paddle

or

Prepare Paddles (if applicable)

Remove paddles from their holders by sliding each paddle toward you, out of the paddle well. Apply a liberal amount of electrolyte gel to the electrode surface of each paddle (or you can use electrode gel patches).

Rub the electrode surfaces together to evenly distribute the applied gel.

Apply Paddles to Chest (if applicable)

Apply paddles firmly to the anterior wall of the chest. Place the Sternum paddle to the right (patient's right) of the patient's sternum, just below the clavicle.

Place the Apex paddle on the chest wall, just below and to the left of the patient's left nipple, along the anterior-axillary line.

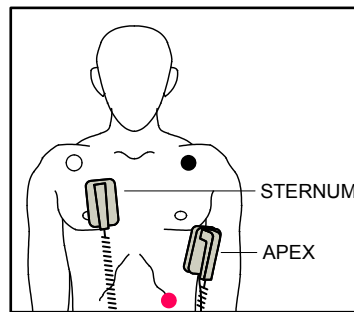

Rub the paddles against the skin to maximize the paddle-to-patient contact.

WARNING

Neonatal and pediatric defibrillator energy levels should be set based on site-specific clinical protocols.

The selected energy level is shown in the *DEFIB XXXJ SEL.* message on the display.

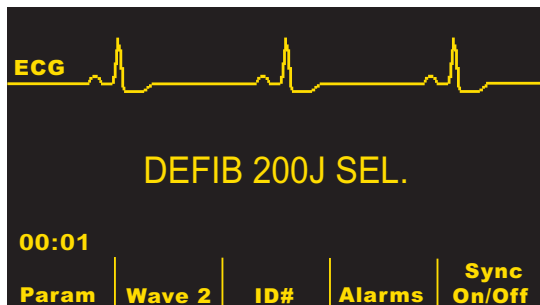

If the unit is configured to do so, it automatically sets the energy to the pre-configured levels for Shock 1, Shock 2, and Shock 3 at power-up and after each of the first two shocks. The *ENERGY INCREMENTED* message appears when this occurs. This function is disabled if you manually change the energy level outside the pre-programmed sequence and deliver a shock. See the E Series Configuration Guide for more details.

WARNING

- Do not permit gel to accumulate between the paddle electrodes on the chest wall (gel bridge). This could cause burns and reduce the amount of energy delivered to the heart.
- If using defibrillator gel pads make sure that the size of the pad is large enough to cover the entire paddle electrode area.

The paddles may be used for ECG monitoring in emergency situations when time does not allow for connection of standard ECG monitoring electrodes.

2 Charge Defibrillator

Press the **CHARGE** button on the front panel (if using MFE pads) or on the apex paddle handle (if using paddles).

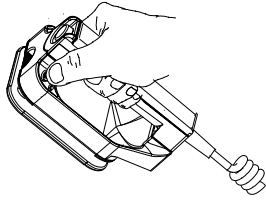

CHARGE Button on
Apex Paddle

or

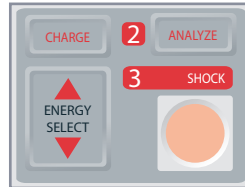

CHARGE Button on
Front Panel

Note: If using paddles, if both **SHOCK** buttons on the paddles are depressed when you press the **CHARGE** button, the device does not charge and a **RELEASE SHOCK BUTTON** or other message appears on the display. To increase or decrease the selected energy after you press the **CHARGE** button, use the defibrillator energy select buttons on either the sternum paddle or the defibrillator front panel.

Note: If using MFE pads, use the defibrillator energy select buttons on the front panel to increase or decrease the selected energy after you press **CHARGE**.

CAUTION

Changing the selected energy while the unit is charging or charged causes the defibrillator to disarm itself. Press the **CHARGE** button again to charge the unit to the newly-selected energy level.

After charging to the selected energy, the charge indicator on the apex paddle lights. If using MFE pads, the **SHOCK** button on the front panel lights. A distinctive charge ready (continuous) tone sounds and the energy ready **DEFIB XXXJ READY** message is displayed. The defibrillator is now ready.

3 Deliver SHOCK

WARNING

- Warn all persons in attendance of the patient to **STAND CLEAR** prior to defibrillator discharge.
- Do not touch the bed, patient, or any equipment connected to the patient during defibrillation. A severe shock can result. Do not allow exposed portions of the patient's body to come in contact with metal objects, such as a bed frame, as unwanted pathways for defibrillation current may result.

- For MFE pad users, press and hold the **SHOCK** button on the front panel until energy is delivered to the patient.

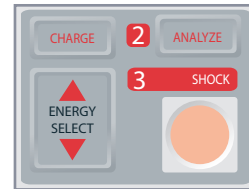

- For paddle users, using your thumbs, simultaneously press and hold both **SHOCK** buttons (one on each paddle) until energy is delivered to the patient.

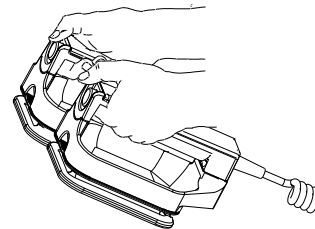

CAUTION

Only use thumbs to depress the **SHOCK** buttons. Failure to do so could result in the inadvertent depression of the **ENERGY SELECT** buttons, causing the defibrillator to disarm itself.

Once energy is delivered, the display simultaneously shows **XXXJ DELIVERED** and **DEFIB XXXJ SEL**. After approximately 5 seconds, the **XXXJ DELIVERED** message disappears, and the **DEFIB XXXJ SEL** message remains to indicate the selected energy level.

Note: If the defibrillator is not discharged within 60 seconds after reaching the selected energy level, the unit automatically disarms itself.

During the 10 seconds prior to disarming, the charge ready tone beeps intermittently. If the 10 seconds elapse and the unit has not discharged during this period, the

device disarms. The charge ready tone stops, the charge indicator light, or the front panel **SHOCK** button light goes off, and the monitor message changes to *DEFIB XXXJ SEL*. Press the **CHARGE** button again to recharge the unit.

Paddle Cleaning

Paddle plates and handles must be thoroughly cleaned after each use. See "General Maintenance" on page 11-1 for correct cleaning procedure.

Troubleshooting

If your E Series unit does not function as expected, see "Troubleshooting Guidelines" on page 13-1.

SECTION 4

ADVISORY DEFIBRILLATION



When MFE Pads are used, the patient connection is considered to be defibrillation-protected Type BF.

Advisory Defibrillation

WARNING

- Do not use the unit's Advisory function on patients under 8 years of age.
- The AutoPulse Plus is only intended for use on adults 18 years of age or older. When using the E Series and AutoPulse Plus as a system, this age restriction applies to the E Series as well.

With Advisory defibrillation, the unit analyzes the patient's ECG rhythm to determine if a shockable rhythm exists. If defibrillation is advised, you charge the defibrillator and deliver shock treatment to the patient.

Note: You cannot use external paddles to defibrillate in Advisory mode. You must use MFE pads for shock delivery.

The E Series unit automatically adjusts defibrillation energy based on configuration settings for Shock 1, 2 and 3. In its factory default configuration, the unit delivers the first three shocks at 120J, 150J, and 200J. You can configure the unit to deliver shocks at other energy levels; see the E Series Configuration Guide for more information.

The Advisory function can only be activated when:

- MFE Pads are connected and selected as the ECG source.
- MFE Pads are firmly attached to the patient.
- The selector switch is turned to DEFIB.

WARNING

The rhythm analysis function may not reliably identify ventricular fibrillation in the presence of an implantable pacemaker. Inspection of the electrocardiogram and clinical evidence of cardiopulmonary arrest should be the basis for any treatment of patients with implantable pacemakers.

Determine Patient Condition Following Medical Protocols

Verify:

- Unconsciousness
- Absence of breathing, and
- Absence of pulse

Begin CPR following medical protocols

Request additional assistance.

Prepare the patient and attach the MFE pads

This is described in "MFE Pad Application/Connection" on page 1-9.

If connecting to PADS through the AutoPulse Plus, refer to the *User Guide AutoPulse® Resuscitation System Model 100 with Defibrillator Interface* addendum (part number 9650-0720-01) for instructions on properly connecting the E Series to the AutoPulse Plus. It is recommended that the user cycle through the lead setting until the APLS icon appears in the upper right-hand corner of the display, indicating that the unit recognizes the connection to the AutoPulse Plus.

WARNING

If the APLS icon does not appear, check that the E Series and AutoPulse Plus are properly connected. If the APLS icon still does not appear, or a PADDLE FAULT occurs, discharge energy internally by changing the energy selection, disconnect the Multi-Function Cable and PADS from the AutoPulse Plus, and connect the Multi-Function Cable directly to the PADS.

1 Select DEFIB

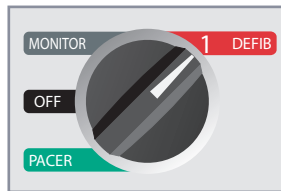

The unit displays the *DEFIB 120J SEL* message on the monitor until you press the **ANALYZE** button.

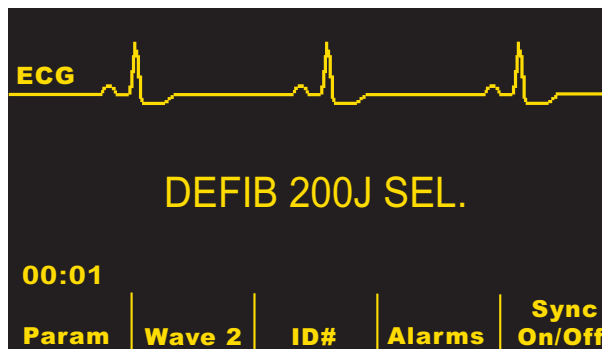

Energy Select

Shock 1, Shock 2, and Shock 3 are set to the default adult settings of 120 J, 150 J, and 200 J respectively.

If medical protocols allow, you may select a different energy level using the **ENERGY SELECT** buttons. The new energy setting is displayed on the monitor.

Automatic energy escalation is disabled if you manually change the energy level outside the pre-programmed Shock 1, Shock 2, Shock 3 sequence and deliver a shock. See the "Energy Level" sections (for Shock 1, Shock 2, and Shock 3) of the E Series Configuration Guide for more details.

2 Press ANALYZE Button

WARNING

- A patient must be motionless during ECG analysis. Do not touch the patient during analysis. Cease all movement via stretcher or vehicle before analyzing the ECG.
- When using the AutoPulse Plus, stop compressions prior to performing ECG analysis. Compressions may be resumed following the analysis.

Press the **ANALYZE** button to begin analysis of the patient's ECG rhythm and to detect the presence of any shockable rhythms.

An *ANALYZING ECG* message is displayed for approximately 9 to 12 seconds while the patient's ECG is analyzed.



Once the analysis is complete, the unit indicates whether or not a shock is advised.

When a non-shockable rhythm is detected, the message *NO SHOCK ADV.* is displayed.

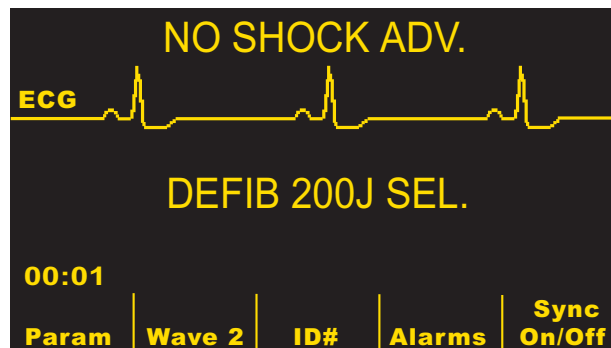

In this case, you should follow local protocols to continue CPR or other cardiopulmonary life support and re-analyze the ECG at appropriate intervals.

When a shockable rhythm is detected (ventricular fibrillation or tachycardia with heart rate > 150):

- Units with the automatic charge option enabled automatically charge the defibrillator to the preconfigured or user selected energy setting.
- Units with the automatic charge option disabled alternately display the messages *SHOCK ADVISED* and *PRESS CHARGE*. In this case, charge the defibrillator by pressing the **CHARGE** button.

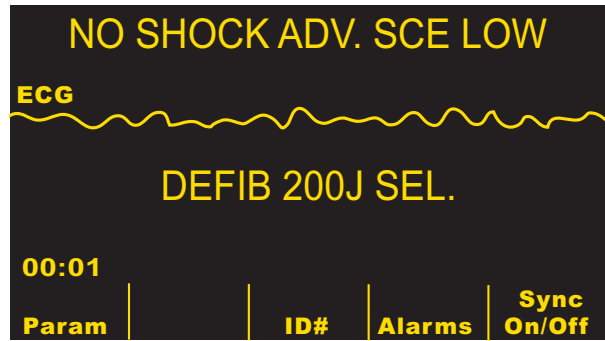
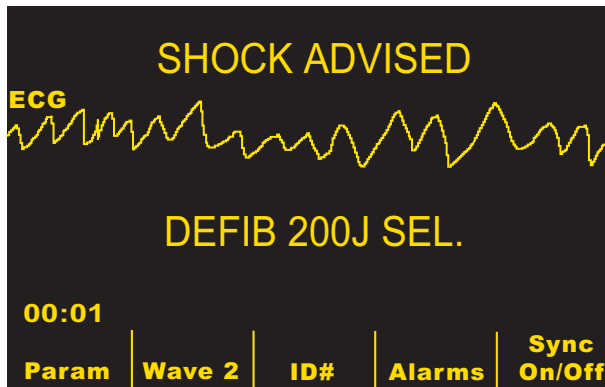

If the patient's SPI value is greater than the configured SPI threshold, the unit operates as previously described and issues the SHOCK ADVISED prompt.

The Shock Conversion Estimator (Optional)

WARNING

Performance of the Shock Conversion Estimator has not been demonstrated in patients under 8 years of age or less than 55 lbs (25 kg).

The Shock Conversion Estimator is an optional enhancement to the E Series unit's ECG Rhythm Analysis Function. The Shock Conversion Estimator can assist rescuers in maximizing the effectiveness of initial therapy for cardiac arrest victims by estimating the probability that the current ECG rhythm will be successfully converted by an immediate defibrillation shock. When the probability that a shock will be successful is low, the performance of CPR may be more beneficial to victim resuscitation efforts than shock delivery.

After the E Series unit has performed its analysis of a patient's ECG rhythm and determined that it is shockable, the Shock Conversion Estimator (when configured) evaluates the heart rhythm and calculates a value called the Shock Predictive Index (SPI). The unit then compares the patient's SPI value to the SPI factory default threshold. If the patient's SPI value after the first ECG Rhythm Analysis is less than this threshold, there is a greater than 95% probability that the shock will **not** convert the patient's heart rhythm to an organized rhythm. Under this condition, the unit issues the NO SHOCK ADVISED prompt, indicating that the preferred method of treatment for the patient should be CPR. The unit can, optionally, display the decision result of the SCE system next to the shock decision, with the message *SHOCK ADVISED SCE HIGH* or *NO SHOCK ADV. SCE LOW*.



The E Series unit can be configured to use the Shock Conversion Estimator for as many as the first four ECG Rhythm Analyses after the unit is powered on. For more information on configuration settings for the Shock Conversion Estimator, refer to the *E Series Configuration Guide*.

The Shock Predictive Index

By default, the Shock Predictive Index threshold is configured for a conversion sensitivity of greater than 95%. This value describes the likelihood that the patient's shockable rhythm will not be converted to an organized rhythm by shock delivery when the SPI is below the default threshold setting. Under these conditions, it may be advisable to continue CPR for an additional period before attempting defibrillation therapy. The Medical Director can adjust the SPI threshold to favor either shock delivery or CPR performance when SPI values are low. For more information on adjusting the SPI threshold, refer to the *E Series Configuration Guide*.

Note: Refer to Appendix A for more information on the background and clinical results of the Shock Conversion Estimator system.

3 Press SHOCK

WARNING

- Warn all persons in attendance of the patient to STAND CLEAR prior to defibrillator discharge.
- Do not touch the bed, patient, or any equipment connected to the patient during defibrillation. A severe shock can result. Do not allow exposed portions of the patient's body to come in contact with metal objects, such as a bed frame, as unwanted pathways for defibrillation current may result.

Once the unit has charged to the selected energy, the **SHOCK** button illuminates, and the **PRESS SHOCK** message is displayed. Simultaneously, the monitor displays the energy level to which the defibrillator has charged in the message **DEFIB XXXJ READY**.



A continuous tone sounds for 50 seconds, followed by an intermittent beeping for 10 seconds. The shock must be delivered within this 60 second interval, or the defibrillator disarms itself.

Press and hold the illuminated **SHOCK** button on the front panel until energy is delivered to the patient. An **XXXJ DELIVERED** message appears on the display for approximately 5 seconds.

Observe the patient or ECG response to be certain that the shock has been delivered.

After the energy is delivered to the patient, the display returns to **DEFIB XXX J SEL**.

Repeat Analysis

Press the **ANALYZE** button to restart an ECG analysis. Determine if additional shocks are required.

Note: Reanalysis of the ECG rhythm, either manually or automatically (see E Series Configuration Guide), is inhibited for 3 seconds after a shock.

Continue Patient Care

Continue patient care according to medical protocols.

Advisory Function Messages

These messages may appear during Advisory defibrillation:

- **SELECT DEFIB MODE**
The **ANALYZE** button is pressed, but the unit is not in the DEFIB mode. Move the selector switch to DEFIB to enable the defibrillator and Advisory capability.
- **SELECT PADS**
The **ANALYZE** button is pressed and the device is being operated in any lead configuration other than PADS. Press **LEAD** button until PADS is selected.
- **DISABLE SYNC**
The **ANALYZE** button is pressed and the device is in DEFIB mode with SYNC on. Turn off SYNC mode by pressing the **SYNC** softkey. Press the **ANALYZE** button again to initiate rhythm analysis on the patient.

Warning Messages

Warning messages prompt the operator to check the patient, the unit, the electrodes and/or connections.

WARNING

The ECG Rhythm Analysis function does not warn the operator of patient asystole, as it is not a shockable rhythm.

These warnings may appear during Advisory defibrillation:

- **NOISY ECG / RETRY ANALYSIS**
Displayed for 5 seconds when the unit detects a noisy ECG signal. Check and adjust electrode placement and cable connections to help eliminate the noise source. Press the **ANALYZE** button again to begin ECG analysis.
- **ECG TOO LARGE / RETRY ANALYSIS**
ECG signal is too large for proper rhythm analysis. Press the **ANALYZE** button again to begin ECG analysis.
- **CHECK PATIENT**
The unit detected a shockable rhythm during continuous background ECG analysis without initiating an analysis (i.e., Smart Alarms™). The prompt is given when the heart rate alarms are enabled and the unit detects a shockable rhythm or if the rhythm goes from non-shockable to shockable. The prompt persists as long as a shockable rhythm is being detected. Press the **ANALYZE** button to begin ECG analysis.

Note: The **CHECK PATIENT** analysis function operates continuously when heart rate alarms are enabled

and does not require depression of the **ANALYZE** button for operation.

- **CHECK PADS / POOR PAD CONTACT**

The MFE Pads are no longer properly attached to the patient or the cable connections have become loose.

Check that the MFE Pads are making good contact with the patient's skin and that the cables are all securely connected. This voice prompt is issued only if MFE pads were previously connected to the patient.

Troubleshooting

If your E Series unit does not function as expected, see the Defibrillator Troubleshooting section starting on page 13-5.

(This page intentionally left blank.)

SECTION 5

AUTOMATED EXTERNAL DEFIBRILLATOR (AED) OPERATION



MFE Pads are a defibrillation-protected Type BF patient connection.

The AED unit has two modes of operation: Semiautomatic or Manual. This section describes the recommended method for analysis and defibrillation for the AED unit in Semiautomatic mode. However, if your local protocol requires a different procedure, follow that protocol.

WARNING

- Do not use the unit's AED function on patients under 8 years of age.
- The AutoPulse Plus is only intended for use on adults 18 years of age or older. When using the E Series and AutoPulse Plus as a system, this age restriction applies to the E Series as well.
- Heart rate alarms are non-operational when the AED unit is in semi-automatic mode.

This section also describes how to switch the AED unit to Manual mode (see "AED Manual Mode Operation" on page 5-5).

The AED unit is capable of analyzing a patient's ECG rhythm in two different ways:

- The always active mode in the background of the Semiautomatic mode (continuous analysis) when MFE Pads or ECG cable and electrodes are in use.
- The user activated mode, initiated by pressing the **ANALYZE** button.

User activated analysis can be performed only when:

- MFE Pads are connected.
- MFE Pads are firmly attached to the patient to reduce any electrode noise or artifact.
- Selector switch is turned to ON.

In Semiautomatic mode, pressing the **ANALYZE** button begins an analysis of the patient's ECG in order to determine if a shockable rhythm is present.

This analysis normally consists of three consecutive 3-second ECG rhythm analyses. If at least two of the three analyses determine that the patient has a shockable rhythm, the unit will automatically charge to the preconfigured energy level and prompt the operator to shock the patient. If two or more of the three 3-second ECG analyses do not detect a shockable rhythm, the unit will alert the operator that no shock is advised. A fourth 3-second interval will be analyzed if any of the first three is noisy.

Following each shock, the continuous analysis function resumes operation and displays and announces a *CHECK PATIENT* prompt if a shockable rhythm is detected. (Continuous analysis runs on a sliding 12 second window of ECG data, producing a result every 3 seconds. If three out of four 3-second segments are shockable, the *CHECK PATIENT* message is issued.)

The *CHECK PATIENT* display and voice prompt are inhibited for 70 seconds (subject to the length of the CPR interval and whether or not *CHECK PULSE* is displayed) following the completion of a user activated analysis or discharge.

WARNING

The rhythm analysis function may not reliably identify ventricular fibrillation in the presence of an implantable pacemaker. Inspection of the electrocardiogram and clinical evidence of cardiopulmonary arrest should be the basis for any treatment of patients with implantable pacemakers.

Note: The AED unit uses the Shock Conversion Estimator function. See page 4-3 for detailed information on this function.

AED Semiautomatic Operation

Before you begin:

- Determine the patient's condition following medical protocols and by verifying:
 - Unconsciousness
 - Absence of breathing, and
 - Absence of pulse
- If appropriate, begin CPR following medical protocol, and request additional assistance.
- Prepare the patient and attach the MFE pads as described in "MFE Pad Application/Connection" on page 1-9.

If connecting to PADS through the AutoPulse Plus, refer to the *User Guide AutoPulse® Resuscitation System Model 100 with Defibrillator Interface* addendum (part number 9650-0720-01) for instructions on properly connecting the E Series to the AutoPulse Plus. It is recommended that the user cycle through the lead setting until the APLS icon appears in the upper right-hand corner of the display, indicating that the unit recognizes the connection to the AutoPulse Plus.

WARNING

If the APLS icon does not appear, check that the E Series and AutoPulse Plus are properly connected. If the APLS icon still does not appear, or a PADDLE FAULT occurs, discharge energy internally by changing the energy selection, disconnect the Multi-Function Cable and PADS from the AutoPulse Plus, and connect the Multi-Function Cable directly to the PADS.

1 Prepare the unit for defibrillation.

Turn the unit to **ON**.

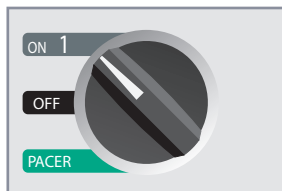

The unit beeps 4 times to indicate that it has passed the power-on self-test. If the audio recorder is present, the unit begins recording audio data immediately.

If you have not yet attached MFE pads or ECG electrodes to the patient and connected to the unit, an **ATTACH PADS** prompt is displayed and announced.

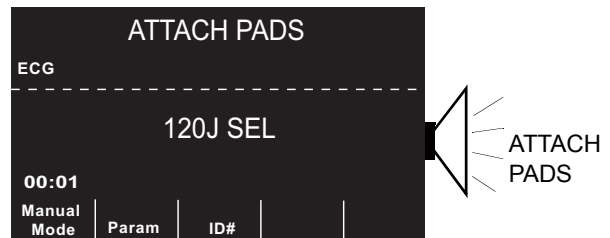

Energy Select

Preconfigured energy levels for Shock 1, Shock 2, and Shock 3 are set to 120, 150, and 200 Joules respectively. If medical protocols allow, and you have configured a different energy level, you may select it by using the **ENERGY SELECT** arrow buttons. The new energy setting is displayed on the monitor.

2 Press ANALYZE Button

WARNING

- Do not use the unit in Semiautomatic mode during patient movement. A patient must be motionless during ECG analysis. Do not touch the patient during analysis. Cease all movement via stretcher or vehicle before analyzing the ECG. If using the device in an emergency vehicle, bring the vehicle to a halt before using in Semiautomatic mode.
- When using the AutoPulse Plus, stop compressions prior to performing ECG analysis. Compressions may be resumed following the analysis.

Press the **ANALYZE** button to begin analysis of the patient's ECG rhythm. The device announces and displays a **STAND CLEAR** prompt.

An **ANALYZING ECG** message is then displayed for up to 12 seconds while the patient's ECG is analyzed.

Note: If MFE pads are not properly attached to the patient, a **CHECK PADS** message is displayed and analysis is inhibited. Check the MFE pads for proper application.

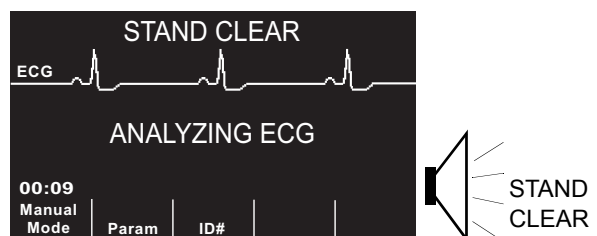

Once the analysis is complete, the unit indicates whether or not a shock is advised.

When a non-shockable rhythm is detected, the unit displays a *NO SHOCK ADV.* message.

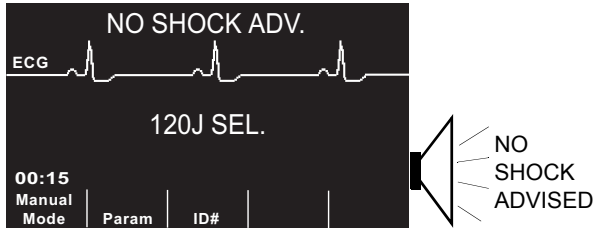

In this case, immediately check pulse and breathing and resume other treatment per protocol.

If the patient's rhythm is shockable, the unit displays a *SHOCK ADVISED* message.

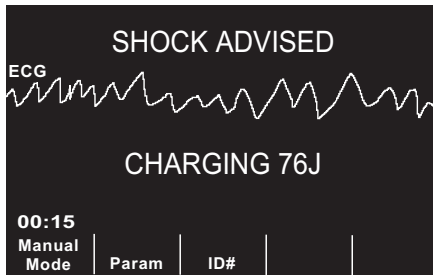

In this case, the defibrillator begins charging to the pre-configured energy setting and displays a *CHARGING* message.

When charging is complete, the monitor displays the energy level to which the defibrillator is charged in the *XXXJ READY* message. The **SHOCK** button illuminates and the *PRESS SHOCK* prompt is announced and displayed.

Note: Rhythm analysis does not continue after the defibrillator is charged and ready once a decision to shock has been made. The E Series will not automatically disarm the defibrillator if the patient's rhythm reverts to a non-shockable rhythm before the shock has been delivered.

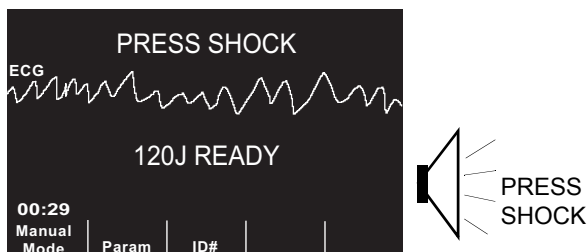

A continuous tone sounds for 10 seconds, followed by an intermittent beeping for 5 seconds. You must deliver the shock within this 15 second interval or the defibrillator disarms itself.

3 Press SHOCK

WARNING

- Warn all persons in attendance of the patient to STAND CLEAR prior to defibrillator discharge.
- Do not touch the bed, patient, or any equipment connected to the patient during defibrillation. A severe shock can result. Do not allow exposed portions of the patient's body to come in contact with metal objects, such as a bed frame. Unwanted pathways for defibrillation current may result.

Press and hold the illuminated **SHOCK** button on the front panel until energy is delivered to the patient.

Observe the patient or ECG response to be certain that the shock has been delivered.

After the energy is delivered to the patient, the display returns to *XXX J SEL. SHOCKS: 1*, indicating the number of shocks administered to the patient.

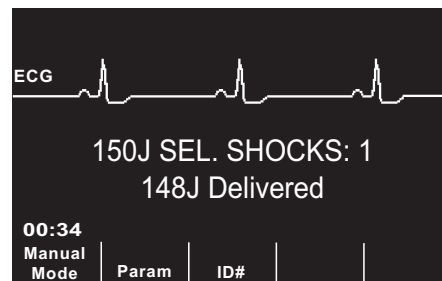

Repeat Analysis

Press the **ANALYZE** button to restart an ECG analysis and to determine if additional shocks are required.

Note: Manual or automatic reanalysis of the ECG rhythm is inhibited for 3 seconds after a shock.

Continue Patient Care

Continue patient care according to medical protocols.

Operating Messages

The unit uses both audio and visual prompts to convey critical information. The following information describes the unit's default message configuration. If your device has been custom configured, some of the information may be different.

There are 9 voice prompts used in Semiautomatic mode. These prompts are accompanied by a prompt displayed on the monitor. The voice prompts are given only once, but the monitor continues to display the prompt until you take new action or the device status changes.

The unit also provides a beeper tone to indicate unit status. Four beeps immediately after turning the unit on signifies the self diagnostics are complete and the unit is

ready for operation. Additional tone signals are described below.

The messages that appear on the monitor depend upon the function the unit is performing, the mode selected, and the ECG information from the patient.

The unit alternately displays two different messages in the same field of the display when two conditions are detected at the same time. For example, a *LOW BATTERY* message may alternately display on the same line of the monitor as the *CHECK PADS* prompt.

The upper portion of the display indicates operator prompts and error messages. The center portion of the display indicates approximately 4 seconds of ECG trace. The lower portion of the display indicates the energy levels selected, the number of shocks delivered during the incident, softkey function labels, and the elapsed time (if enabled). Additional unit status information is also displayed on the monitor.

When elapsed time is enabled, this feature indicates the elapsed time since the unit was first turned on. It is displayed in the lower left corner. The elapsed time is displayed in MM:SS format up to 99:59. If the unit is on for over 100 minutes, the elapsed time rolls over to 0. The elapsed time is maintained for up to 10 seconds after power down. This gives you adequate time to change the unit's battery without resetting the elapsed time.

Audio and Display Messages

The following messages can occur during Semiautomatic operation to guide you through the cardiac event.

Note: Messages with an asterisk (*) are accompanied by a voice prompt.

- *ATTACH PADS**
This prompt appears if the unit is powered on without MFE Pads or ECG leads attached.
- *PRESS ANALYZE**
This prompt appears under the following conditions:
 - After the unit is charged, but no shock was delivered.
 - 70 seconds (subject to the length of the CPR interval and whether or not *CHECK PULSE* is displayed) after completion of an analysis with a NO SHOCK ADVISED outcome, if the unit is configured to auto analyze 3 times.
 - 70 seconds (subject to the length of the CPR interval and whether or not *CHECK PULSE* is displayed) after delivery of the third shock in three-analyses sequence, if the unit is configured to auto analyze 3 times.
- *ANALYZING ECG/STAND CLEAR**
These messages appear after pressing the **ANALYZE** button. They indicate that an active ECG analysis is in progress.

- *ECG TOO LARGE/RETRY ANALYSIS*
These messages appear when the ECG signal is too large for proper rhythm analysis. Press the **ANALYZE** button again to begin ECG analysis.
- *ANALYSIS HALTED*
This message appears when the unit has detected a problem during ECG analysis. Check connections and press the **ANALYZE** button again.
- *CHARGING XXXJ*
This message appears when ECG analysis is still in progress and a potentially shockable rhythm has been detected. The current charge level and a message that the unit is charging are displayed.
- *SHOCK ADVISED/CHARGING XXXJ*
These messages appear when ECG analysis has determined that a shockable rhythm exists and defibrillation is advised. The selected charge level has not yet been reached. The current charge level and a message that the unit is charging are displayed.
- *SHOCK ADVISED/XXXJ READY*
This message appears when ECG analysis has determined that a shockable ECG rhythm is present, the unit has charged, and the selected energy is ready to be delivered.
- *PRESS SHOCK**
This prompt appears when ECG analysis has determined that a shock is advised and the selected energy is ready to be delivered.
- *RELEASE SHOCK*
This message appears when the **SHOCK** button is pressed during charging (before the *DEFIB XXX J READY* message). The unit beeps when this message appears. If the **SHOCK** button remains depressed for 15 seconds after the ready tone begins, the unit disarms itself. If the **SHOCK** button is released before 15 seconds has elapsed, the *PRESS SHOCK* prompt appears and the shock can be delivered.
- *SHOCKS: XX*
This message indicates the number of shocks that have been delivered by the unit since power on. This value is reset to 0 after the unit has been off for more than 10 seconds. (This 10 second delay allows replacing a battery without resetting the shock count.)
- *NO SHOCK ADVISED**
This message appears and continues for 10 seconds when ECG analysis determines that a non-shockable rhythm is detected following completion of the analysis. Press the **ANALYZE** button to start another ECG analysis
- *CHECK PULSE**

This prompt appears when the unit has detected a non-shockable rhythm. Check the patient's pulse.

- **IF NO PULSE, PERFORM CPR***
If you cannot detect a pulse, begin CPR protocols.
- **CHECK PADS***
This prompt appears when MFE pads or the MFC cable has become disconnected from the patient.
- **CHECK PATIENT***
This message appears when background ECG analysis has detected a shockable ECG rhythm. Press **ANALYZE** to analyze ECG and, if needed, begin charging.
- **MONITOR**
This message appears when the ECG cable is connected to its input connector, attached to the patient and the Multi-Function cable is not in use. The unit selects lead II and sets the ECG size automatically (you cannot change the Lead and ECG size).

AED Manual Mode Operation

To enter the Manual mode of operation, press the **Manual Mode** softkey on the front panel of the unit.



Based on whether or not the device has been configured with an access code, one of the following two screens is displayed.

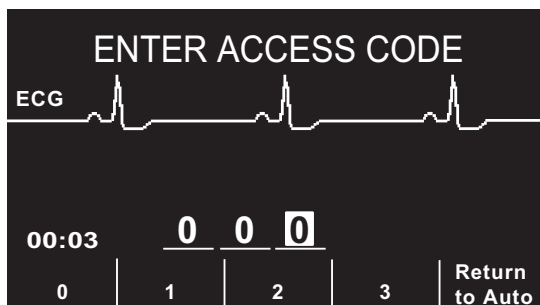

If you see the screen above, you must enter a three-digit access code to enter Manual mode. Press the individual softkey corresponding to the digit to be entered (each digit entered must be between 0 and 3). The highlight automatically moves to the next space. Repeat until you

have entered the access code correctly and the unit enters Manual mode.

If you press the **Return to Auto** softkey, the unit returns to the Semiautomatic mode of operation.

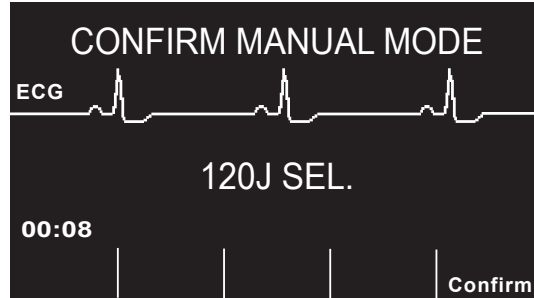

If you see the screen above, the access code is not configured. Press the **Confirm** softkey to enter the Manual mode of operation. You must press the **Confirm** softkey within 5 seconds, or the unit reverts back to Semiautomatic operation.

For information on operating in Manual mode, refer to:

- "Manual Defibrillation" on page 3-1
- "Advisory Defibrillation" on page 4-1
- "NonInvasive Temporary Pacing (Pacer Version Only)" on page 9-1
- "ECG Monitoring" on page 10-1

Troubleshooting

If your E Series unit does not function as expected, see the "Troubleshooting Guidelines" on page 13-1.

(This page intentionally left blank.)

SECTION 6

SYNCHRONIZED CARADIOVERSION



Paddles are a defibrillation-protected Type BF patient connection.



ECG leads are a defibrillation-protected Type CF patient connection.

WARNING

- Only skilled personnel trained in ACLS (Advanced Cardiac Life Support) and familiar with equipment operation should perform synchronized cardioversion. The precise cardiac arrhythmia must be determined before attempting defibrillation.
- Prior to attempting synchronized cardioversion, ensure that the ECG signal quality is sufficient to minimize risk of synchronizing on artifact.
- Synchronized cardioversion is disabled when the E Series unit is connected to the AutoPulse Plus and the AutoPulse Plus is compressing.

Certain arrhythmias, such as ventricular tachycardia (VT), atrial fibrillation, and atrial flutter, require synchronizing the defibrillator discharge with the ECG R-wave to avoid the induction of ventricular fibrillation. In this case, a synchronizing circuit within the instrument detects the patient's R-waves. When the **SHOCK** buttons are pressed and held, the unit discharges with the next detected R-wave, thus avoiding the vulnerable T-wave segment of the cardiac cycle.

When SYNC mode is turned on, the unit places markers above the ECG trace to indicate the points in the cardiac cycle where discharge will occur. The sync markers appear as arrows (↴) above the ECG trace.

The synchronized cardioversion procedure for MFE Pads is identical to that for paddles with the exception of the **SHOCK** button location.

Synchronized Cardioversion

Determine patient condition and provide care following medical protocols.

Prepare Patient

Remove all clothing covering the patient's chest. Dry chest if necessary. If the patient has excessive chest hair, clip it to ensure proper adhesion of electrodes.

Attach the following to the patient as appropriate:

- **ECG electrodes** (recommended for ECG source) as described in "ECG Monitoring" on page 10-1.
- **MFE pads** described in "MFE Pad Application/ Connection" on page 1-9.

A standard ECG cable and ECG electrodes are recommended for monitoring during cardioversion. You can use MFE Pads as an ECG source; signal quality is equal to that of standard leads except immediately following a discharge when there may be more noise due to muscle tremors, especially if a pad is not in complete contact with the skin.

- **Paddles** as described in "Emergency Defibrillation Procedure with Paddles or MFE Pads" on page 3-1.

Note, however, that synchronized discharge with PADDLES as an ECG source is discouraged since artifacts induced by moving the paddles may resemble an R-wave and trigger defibrillator discharge at the wrong time.

Standard ECG leads are recommended during cardioversion since they provide signal quality that is typically superior to that of paddles.

- Note:** An *ECG LEAD OFF* condition does prevent synchronized discharge if leads are selected as the ECG source. It does not, however, prevent the use of the defibrillator; it simply prevents use in a synchronized manner.

Turn Selector Switch to MONITOR

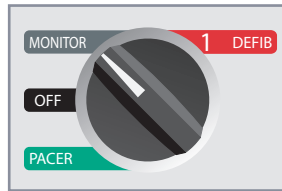

Press the **LEAD** button to select the desired ECG lead. The lead you select is then displayed at the top of the screen.

1 Select DEFIB

Turn the selector switch to DEFIB, then select the desired energy level using the up/down arrows on the front panel or sternum paddle (if being used).

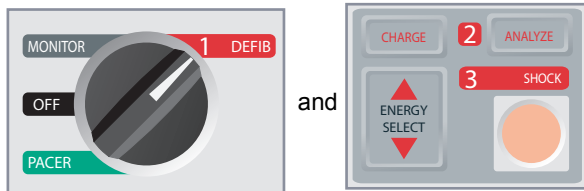

Press SYNC softkey

The selected energy level is displayed on the monitor.

A SYNC marker (↓) appears on the monitor above each detected R-wave to indicate where discharge will occur.

Verify that markers are clearly visible on the monitor and their location is appropriate and consistent from beat to beat. If necessary, use the **LEAD** button and **SIZE** button to establish settings that yield the best display.

- A *SYNC XXXJ SEL.* message appears on the display. If the *DEFIB XXXJ SEL.* message appears, press the **SYNC** softkey. Two quick beeps sound when the **SYNC** softkey is pushed.

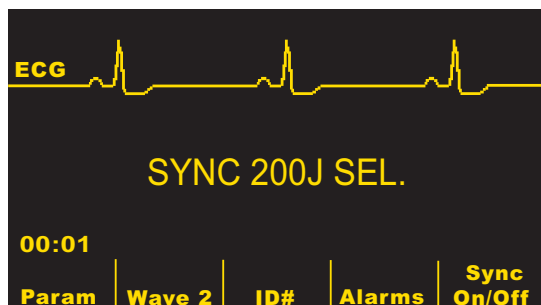

Unless otherwise configured, Sync mode is turned off automatically after each shock or if the selector switch has been moved to PACER or OFF.

Press the **SYNC** softkey again to reactivate SYNC mode. Changing the selected energy does not turn off Sync mode.

You can configure the unit to stay in Sync mode after defibrillation if desired.

2 Charge Defibrillator

Press the **CHARGE** button on the front panel or on the apex paddle handle (if paddles are used).

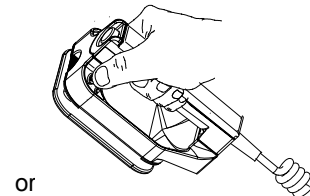
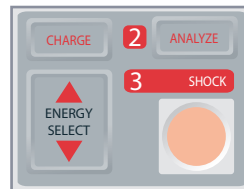

CAUTION

Changing the selected energy while the unit is charging or charged will cause the defibrillator to disarm itself. Press the **CHARGE** button again to charge the unit.

To abort charging and increase or decrease the selected energy after you press the **CHARGE** button, use the **ENERGY SELECT** buttons on either the sternum paddle (if paddles are used) or defibrillator front panel. Press the **CHARGE** button again to charge the unit.

After charging to the selected energy, the **SHOCK** button on the front panel lights. If paddles are used, the charge indicator on the apex paddle illuminates. A distinctive audible tone sounds and the energy ready *SYNC XXXJ READY* message is displayed.

The defibrillator is now ready.

3 Deliver SHOCK

WARNING

- Warn all persons in attendance of the patient to **STAND CLEAR** prior to defibrillator discharge.
- Verify that no one is in contact with the patient, monitoring cable or leads, bed rails, or any other potential current pathways.

Verify that the ECG waveform is stable and that a marker appears only with each R-wave.

Press and hold the illuminated, front panel **SHOCK** button or, if paddles are used, simultaneously press and hold both **SHOCK** buttons (one on each paddle) until energy is delivered to the patient. The defibrillator discharges with the next detected R-wave.

Once energy is delivered, the display simultaneously shows the *XXXJ DELIVERED* and *DEFIB XXXJ SEL.* messages. After approximately 5 seconds the *XXXJ DELIVERED* message disappears, and the *DEFIB XXXJ SEL.* message remains to indicate the selected energy level.

If additional countershocks are necessary, re-adjust the energy level as necessary, press the **SYNC** softkey and repeat. Note the *SYNC XXXJ SEL.* message must be displayed prior to pressing the **CHARGE** button.

If it is necessary to disarm the charged defibrillator (if countershock is not needed), turn the selector switch to MONITOR or change the selected energy level. Any stored energy is discharged internally by the defibrillator.

If the **ANALYZE** button is pressed while the unit is in SYNC mode, the unit displays *DISABLE SYNC* and disallows ECG rhythm analysis until the unit is taken out of SYNC mode.

If the defibrillator is not discharged within 60 seconds after reaching the selected energy level, it automatically disarms itself. During the ten seconds prior to this internal disarm, the charge ready tone beeps intermittently. The charge ready tone then stops and the defibrillator remains in SYNC mode.

Troubleshooting

If your E Series unit does not function as expected, see the Defibrillator Troubleshooting section starting on page 13-5.

(This page intentionally left blank.)

SECTION 7

REAL CPR HELP



The CPR sensor is defibrillation-proof Type BF equipment.

WARNING

- The Real CPR Help® function is not intended for use on patients under 8 years of age.
- The CPRD-to-MFC connector is intended for use with the E Series, or other ZOLL defibrillators where indicated.
- Real CPR Help is disabled when using CPR-D-padz through an AutoPulse Plus.

When used with CPR-D-padz, the E Series unit can provide rescuers with feedback about the quality of CPR they are delivering to their patients. The way in which feedback is provided varies with respect to the operational mode and user configuration, but is derived from compression rate and depth measurement. The CPR Dashboard™ contains additional features such as the Compression Release Bar.

When applied according to package instructions, ZOLL CPR-D-padz provide a chest compression sensor that is located between the rescuer's hands and the patient's lower sternum. This sensor monitors the rate and depth of chest compressions and sends this information to the E Series unit for processing and display.

The E Series defibrillator uses this information to provide feedback to the rescuer in one or more of the following forms:

- CPR Index™
- CPR Idle Time Display
- CPR Rate Metronome
- Voice prompts
- Chest Compressions Bar Graph
- Informational Messages

Prepare the Patient and Attach the CPRD-to-MFC Connector

Prepare the patient as described on page 1-9. Attach the CPR-D-padz to the patient according to the instructions on the electrode packaging. Connect the Multifunction cable to the narrow end of the CPRD-to-MFC connector (if not already connected). Connect the CPR-D-padz to the wide end of the CPRD-to-MFC connector.

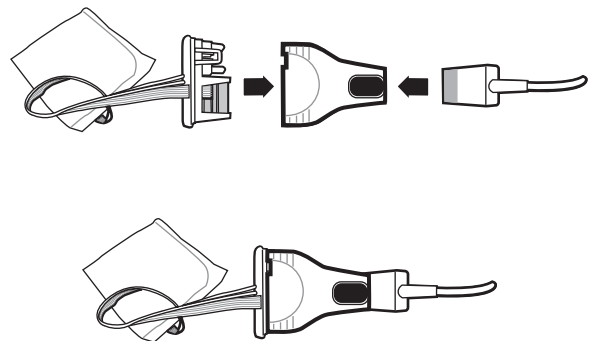

Ensure that the CPR-D-padz are making good contact with the patient's skin. If the pads are not making good contact, the messages *CHECK PADS* and *POOR PAD CONTACT* will be displayed, and energy will not be delivered. If a short circuit exists between the pads, the message *DEFIB PAD SHORT* will be displayed.

Note: If the E Series displays the message *CABLE FAULT* or *PADDLE FAULT*, energy will not be delivered. Check the connection to the CPRD-to-MFC connector. If the message does not clear, disconnect the CPRD-to-MFC connector and connect the cable directly to the CPR-D-padz. If the fault clears, CPR feedback will not be available, but the device will be able to deliver energy.

Real CPR Help Field

Whenever CPR-D-padz are connected to the E Series defibrillator and the CPR Dashboard is configured off, the unit illuminates the Real CPR Help field in the upper right side of the display. This field includes the CPR

compression indicators and CPR idle time described in the next sections.

CPR Compressions Indicator

This rectangular bar shaped figure provides a quick, overall indicator of how well the rescuer's combined rate and depth of chest compressions match the AHA/ERC recommendations for adult CPR.

Before chest compressions begin (and after each shock), the Chest Compression Indicator is displayed as a hollow outline. This indicator starts to fill with color as compressions begin (filling from left to right), and becomes fully filled when consistent chest compression depth exceeding 1.75 or 2.0 inches (depending on the configuration) and rate exceeding 90 compressions per minute (cpm) are achieved simultaneously. Should the chest compression rate or depth begin to fall below the AHA/ERC recommended levels, the indicator will only partially fill to indicate the need for more vigorous efforts. Following the cessation of compressions, the indicator's fill level gradually decreases until a hollow outline is displayed after a short period of time.

When complete filling of the CPR Compression Indicator has not been achieved due to diminished compression rate or depth, the E Series will display the letter R for Rate and/or the letter D for depth to assist the rescuer in determining whether chest compression rate or depth should be increased. When an appropriate rate and depth have been achieved, these letters will disappear from the display field.

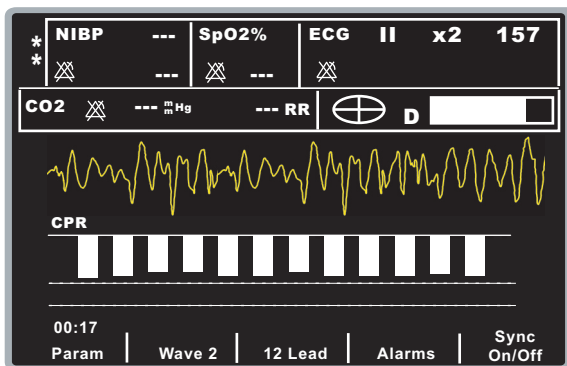

CPR Idle Time Display

This display indicates the elapsed time in minutes and seconds since the last detected chest compression. When compressions are being delivered at a rate of 11 cpm or higher, the idle time will not be displayed. Ten seconds following the cessation of compressions, the idle time will be displayed in place of the Compression Indicator bar. As soon as a new compression is detected, the idle time is removed from the screen. If no

compressions have been delivered for more than 20 minutes, dashes (---) will be displayed in this time field.

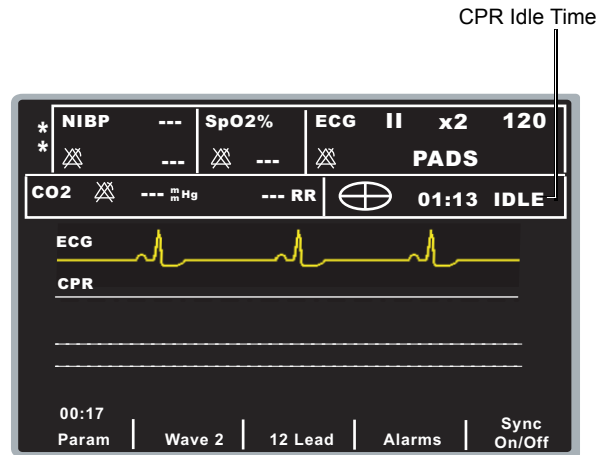

FULLY RELEASE Prompt

The E Series unit can be configured to display the text prompt, *FULLY RELEASE*, which instructs rescuers to lift (fully release) their hands from the patient's chest after compressions to allow full recoil.

By default, the *FULLY RELEASE* text prompt is not enabled.

CPR Voice Prompts

The E Series can be configured to issue voice prompts related to the depth of chest compressions as feedback to rescuers performing CPR. Two voice prompts are available for this purpose:

- Push Harder
- Good Compressions

When chest compressions are detected but their depth is consistently less than 1.5 or 2 inches (3.8 or 5 cm) depending on the configuration, the defibrillator will periodically issue the prompt "Push Harder". If the rescuer responds by increasing compression depth on a consistent basis to more than 1.5 or 2 inches (3.8 or 5 cm), depending on the configuration, the unit will issue a "Good Compressions" prompt.

See the *E Series Configuration Guide* for information on enabling/disabling CPR voice prompts.

Compressions Bar Graph

The E Series can display a CPR compression bar graph computed from the CPR sensor signals. This bar graph, representing depth of compression, is presented on a displacement scale with a reference marker at 1.5 or 2.0 inches, depending on the configuration. The E Series displays a minimum of 12 seconds of compression data.

Displaying the CPR Compressions Bar Graph

To manually display the CPR compression bar graph, press the **Wave 2** softkey until the bar graph is displayed.

CPR Dashboard

Whenever CPR-D-padz or CPR stat-padz are connected to the E Series unit and the CPR Dashboard is configured on, the unit illuminates the CPR Dashboard, replacing the right half of the Wave 2 display area. You can use the Wave 2 softkey to select other data for Wave 2, including full width displays of the waveforms.

The Dashboard includes the indicators described in the following sections.

CPR Feedback Indicators and CPR Index

The diamond-shaped figure provides a quick, overall indicator of how well the rescuer's combined rate and depth of chest compressions match the AHA/ERC recommendations for adult CPR.

Before chest compressions begin (and after each shock), the Chest Compression Indicator appears as a hollow outline. This indicator starts to fill with color as compressions begin (filling from the center out), and becomes filled when consistent chest compression depths exceed 1.5 or 2 inches and the compression rate exceeds 90 compressions per minute (cpm) simultaneously. Should the chest compression rate or depth begin to fall below the AHA/ERC recommended levels, the indicator will only partially fill to indicate the need for more vigorous efforts. When compressions cease, the indicator's fill level gradually decreases until a hollow outline appears.

The Compression Release Bar shows the release of the chest compression by the rescuer. When the release of the chest is properly administered, the bar will fill all the way to the top.

CPR Rate and Depth Display

If the CPR Dashboard is configured On and the CPR Idle Time is not displayed, the Rate and Depth values will be displayed in the CPR Dashboard. The values will be highlighted and displayed in red if they are below the appropriate values.

When an appropriate rate and depth are achieved, these labels are not highlighted.

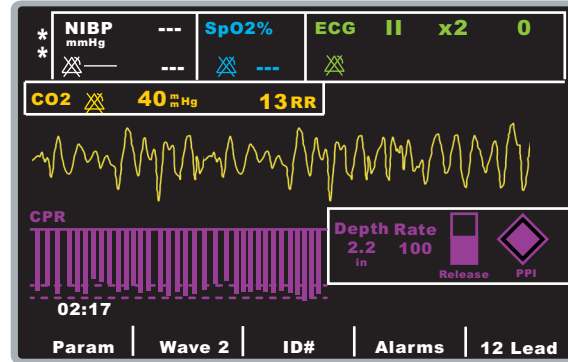

CPR Idle Time Display

This display indicates the elapsed time in minutes and seconds since the last detected chest compression. When compressions are being delivered at a rate of 35 cpm or higher, the idle time is not displayed. The idle time is displayed in place of the Rate and Depth values after compressions have ceased for ten seconds. As soon as new compressions are detected, the idle time is removed from the screen.

If no compressions have been delivered for more than 20 minutes, dashes (---) will be displayed in this time field.

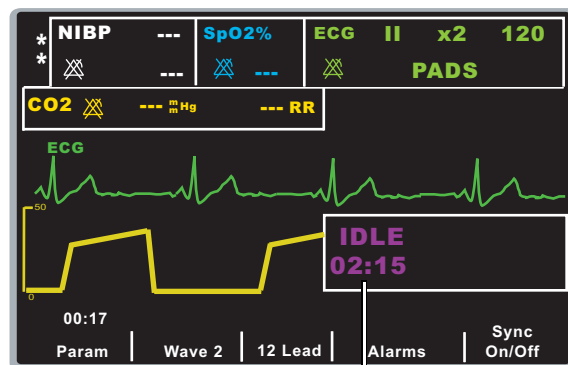

CPR Idle Time

(This page intentionally left blank.)

SECTION 8

SEE-THRU CPR

WARNING

- The See-Thru CPR filter works only when the E Series defibrillator is monitoring CPR in Manual mode.
- The See-Thru CPR filter stops if:
 - Diagnostic bandwidth mode is active.
 - The unit is in pace mode.
 - Patient impedance is invalid.
 - CPR-D-padz electrodes are no longer detected.
- The See-Thru CPR filter will not remove all CPR artifact. Always stop CPR to verify the patient's ECG rhythm before making treatment decisions.
- The See-Thru CPR filter does not operate during ECG rhythm analysis. Always stop chest compressions during ECG rhythm analysis to avoid incorrect results caused by the presence of CPR artifact.
- The See-Thru CPR filter does not operate when pads are connected through an AutoPulse Plus.

See-Thru CPR[®] enables the rescuer to see a close approximation of the patient's underlying ECG rhythm while performing CPR. See-Thru CPR is available if the E Series is monitoring CPR.

Chest compressions introduce *CPR artifact* into the ECG signal. See-Thru CPR uses a filter that relies on the correlation between CPR compressions, as detected by the ZOLL CPR-D-padz electrodes, and the CPR artifact to remove much, but not all, of the artifact from the ECG signal. Under some conditions, residual noise after filtering can obscure the ECG rhythm, requiring the rescuer to stop CPR to assess the ECG. For example, in the case of asystole or low amplitude PEA, the residual artifact seen after filtering may look like fine ventricular fibrillation.

Because the filtered ECG signal may contain residual chest compression and/or filtering artifacts, *a rescuer should always follow the standard procedure of stopping CPR to assess the patient's ECG rhythm before determining treatment.*

Using See-Thru CPR

To use See-Thru CPR

- The E Series unit must be monitoring CPR.
- CPR-D-padz electrodes must be attached to the unit.

When a rescue begins, an E Series unit *automatically* starts filtering the CPR artifact after detecting the first 3 to 6 compressions. The filtered ECG, with the label "FILT ECG," may be displayed on the second waveform (by pressing the **Wave 2** softkey).

See-Thru CPR filtering continues as long as the CPR-D-padz electrodes detect compressions and patient impedance is valid. When no compressions are detected or one of the conditions noted above occurs, See-Thru CPR filtering stops, unfiltered ECG signals are displayed, and the unit changes the label on the second waveform to "ECG." When compressions resume, filtering automatically restarts after 3 to 6 chest compressions.

If configured to display the CPR Dashboard, the E Series unit can also be configured to display the filtered ECG in Trace1.

Examples

The following examples show the effects of See-Thru CPR filtering on ECG signals contaminated with CPR artifacts.

Each example includes:

- ECG signal with CPR artifact.
- ECG signal after the See-Thru CPR filter has removed CPR artifact.
- Indication of the period during which See-Thru CPR is active.
- CPR signal to show when CPR activity occurred.

The following figure shows a patient in Fine VF. It is difficult for a rescuer to discern this rhythm during CPR compressions. When the CPR filter turns on, the Fine VF rhythm becomes more obvious.

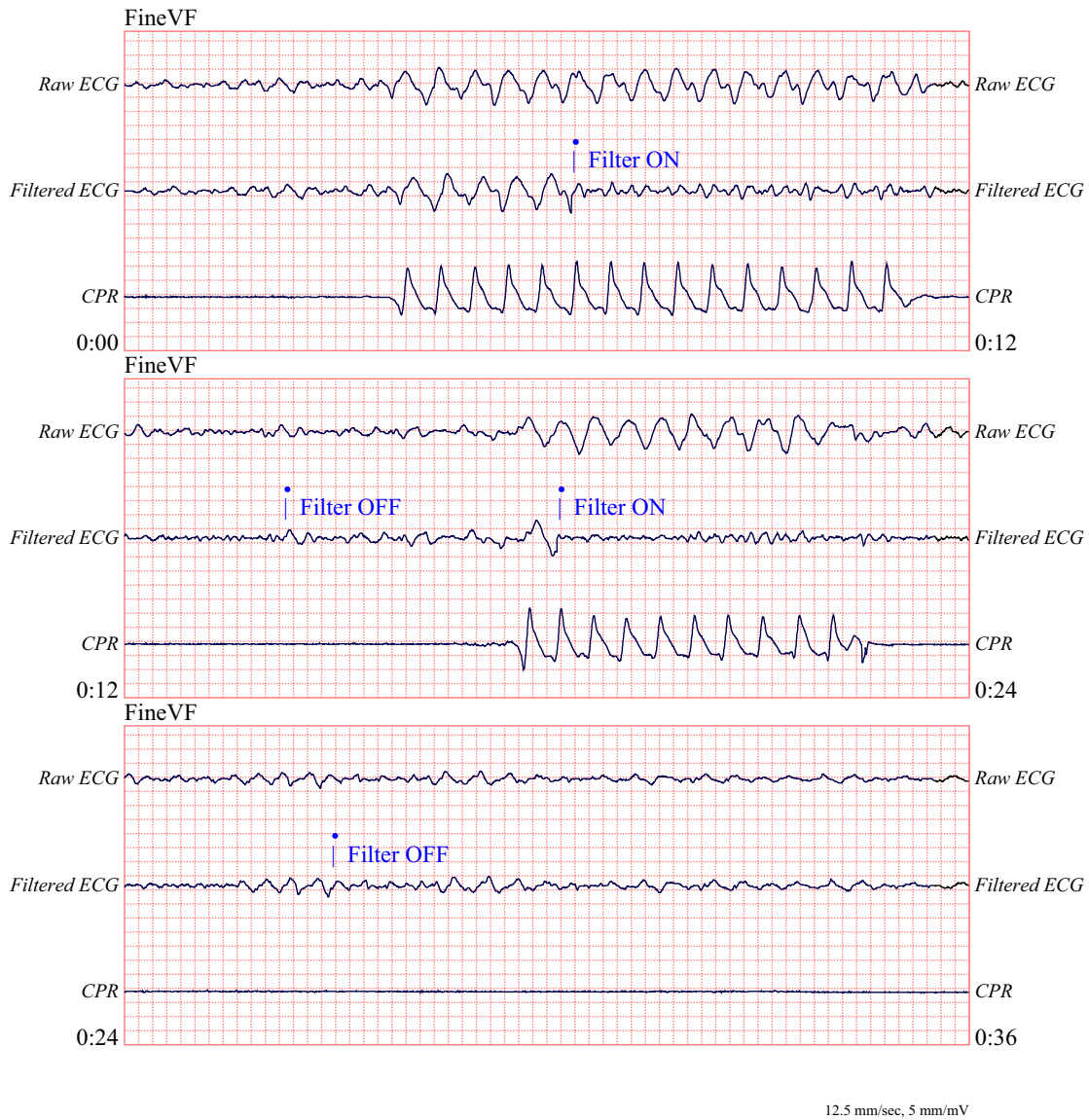

The following figure shows a patient in VF, which, during compressions, is slightly more difficult to discern. When viewing this ECG, it is possible to view the underlying rhythm as the filter is able to reject all of the CPR artifact.

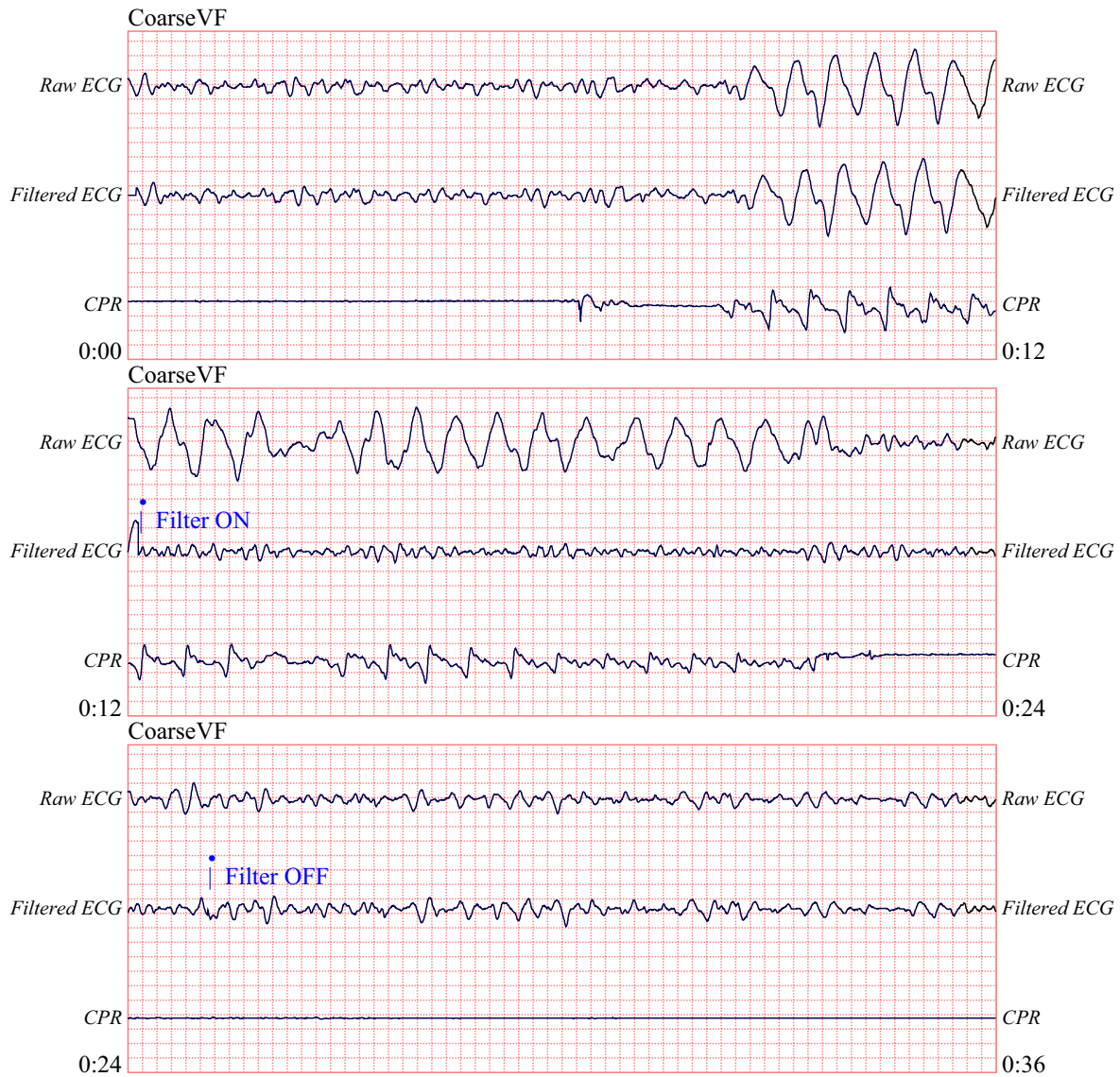

12.5 mm/sec, 5 mm/mV

The following figure shows a patient in PEA, which could easily be mistaken for Fine VF because enough of the compression artifact leaks through to distort this signal. When the CPR filter turns on, the PEA is still not obvious because of the left over ripples from the CPR signal. About 14 seconds into this chart, the rhythm changes to asystole, which could easily be mistaken for coarse VF. When the CPR filter turns on, the CPR compression ripples are still obvious, making the rhythm look like Fine VF.

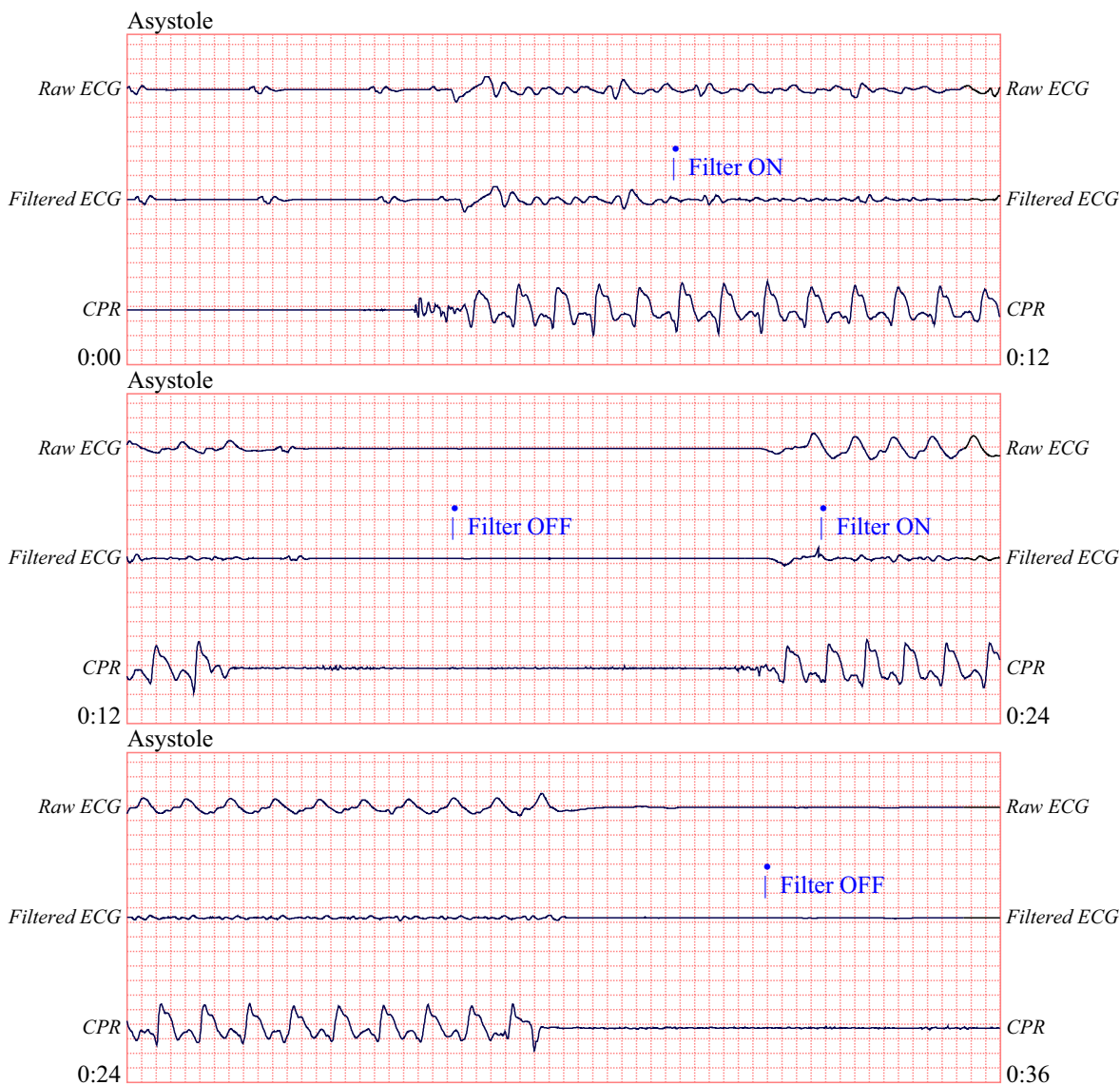

12.5 mm/sec, 5 mm/mV

The following figure shows a patient with an organized rhythm where See-Thru CPR effectively filters out artifact created by CPR.



12.5 mm/sec, 5 mm/mV

(This page intentionally left blank.)

SECTION 9

NON INVASIVE TEMPORARY PACING (PACER VERSION ONLY)



Paddles are a defibrillation-protected Type BF patient connection.



ECG leads are a defibrillation-protected Type CF patient connection.

WARNING

- To avoid risk of electrical shock, do not touch the gelled area of the MFE Pads while pacing.
- MFE Pads should be replaced after 8 hours of continuous pacing (2 hours for Radiolucent stat-padz) to ensure maximum patient benefit.
- Pacing with CPR-D-padz is not recommended. For the most effective pacing, use MFE pads.
- Prolonged pacing (in excess of 30 minutes), particularly in neonates or adults with severely restricted blood flow, may cause burns. Periodic inspection of the underlying skin is recommended.
- If the unit was not turned off and less than 10 minutes have elapsed since the pacing mode was last used, reactivating the pacer mode causes pacing to immediately resume at the previously selected mA and ppm settings.
- Pacing must be turned off before defibrillating with a second defibrillator. Otherwise, the E Series unit may be damaged.

Noninvasive Temporary Pacing

Some E Series products contain a VVI demand pacemaker — a safe and effective design for Noninvasive Temporary Pacemakers. Proper demand pacing requires a reliable, high-quality surface ECG signal.

Determine patient condition and provide care following medical protocols.

Prepare Patient

Remove all clothing covering the patient's chest. Dry chest if necessary. If the patient has excessive chest hair, clip it to ensure proper adhesion of electrodes.

1 Apply Electrodes and/or MFE Pads

Connect the electrodes to the ECG cable leads, and the ECG cable to the E Series unit. Apply ECG electrodes (refer to "ECG Monitoring" on page 10-1). Adjust the ECG size and lead for a convenient waveform display. Verify proper R-wave detection. The heart-shaped symbol flashes with each R-wave when proper detection is taking place.

Attach and connect the MFE pads

This is described in "MFE Pad Application/Connection" on page 1-9.

2 Turn Selector Switch to PACER

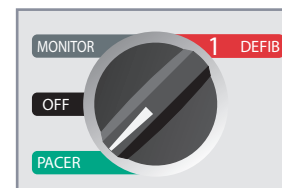

Set Pacer Output to 0 mA

If the unit has just been turned on, the PACER OUTPUT is automatically set to 0 mA.

3 Set Pacer Rate

Set PACER RATE to a value 10-20 ppm higher than patient's intrinsic rate. If no intrinsic rate exists, use 100 ppm.

The pacer rate increments or decrements by a value of 2 ppm on the display when you turn the knob.

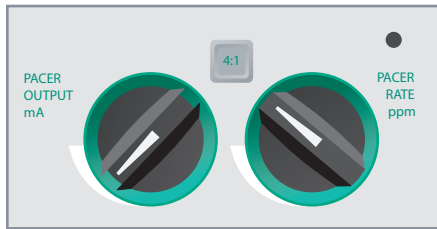

Observe the pacing stimulus marker on the display or stripchart (⏏) and verify that it is well-positioned in diastole.

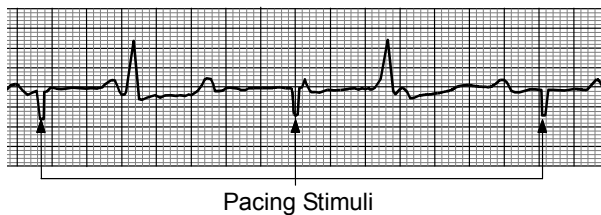

4 Set Pacer Output

Increase PACER OUTPUT mA until stimulation is effective (capture). Output mA value is displayed.

The pacer output increments or decrements by a value of 2 mA on the display as you turn the knob.

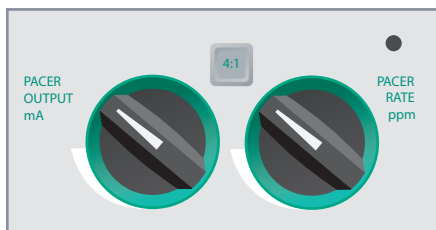

Note: When the device is switched out of Pacer mode into Defib or Monitor mode for less than 10 minutes, and then switched back to Pacer mode, the Pacer settings remain unchanged.

If the unit is turned off for more than 10 seconds, the pacer default settings are restored.

5 Determine Capture

Capture refers to the state when the heart is being paced by the unit rather than the body's own pacemaker mechanism. Capture consists of two parts: electrical and mechanical capture. You must verify capture both electrically and mechanically to ensure appropriate circulatory support of the patient.

Electrical Capture

Electrical capture means that the unit is delivering sufficient electrical current to stimulate the heart as seen on the ECG trace.

WARNING

- You should only assess electrical capture by viewing the ECG on the screen with the ECG unit's cable directly attached to the patient.
- Use of other ECG monitoring devices may provide misleading information due to the presence of pacer artifacts.

The shape and size of the paced ECG waveforms can vary depending on the ECG lead configuration chosen and depending on the patient. Electrical capture is indicated if:

- Each stimulus marker is followed by a wide QRS complex
- There is no underlying intrinsic rhythm
- An extended, and sometimes enlarged, T-wave appears.

The following figure shows ECG tracings that are typical of effective pacing:

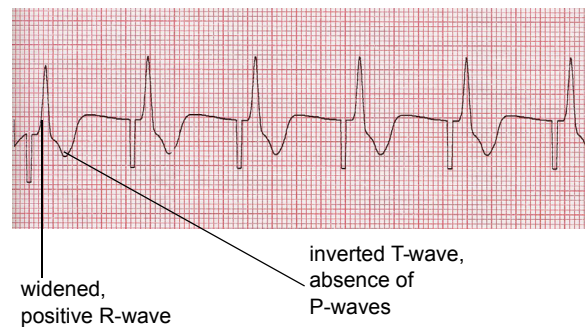
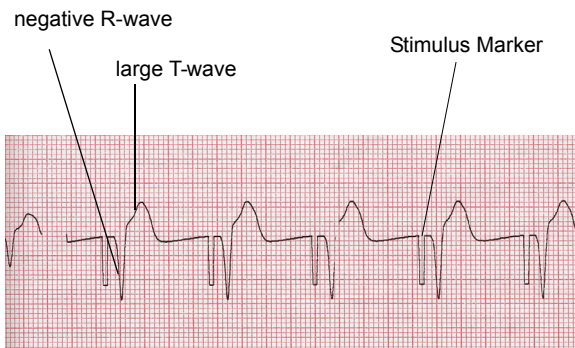

Intermittent capture is indicated when some stimulus markers are not immediately followed by wide QRS complexes; you can compensate for intermittent capture

by increasing the pacer output (mA) until every pacing marker is immediately followed by a wide QRS complex.

Note that changing ECG leads and size can sometimes be helpful in determining capture.

Mechanical Capture

Mechanical capture is indicated when the patient’s pulse approximates the displayed pace rate.

Because pacing stimuli generally causes muscular contractions that can be mistaken for a pulse, you should never take a pulse on the left side of the body. Similarly, pectoral muscle contractions due to pacing stimuli do not indicate mechanical capture. To avoid mistaking muscular response to pacing stimuli for arterial pulsations, use ONLY the following locations for taking palpating pulse during pacing:

- Femoral artery
- Right brachial or radial artery.

6 Determining Optimum Threshold

The ideal output current is the lowest value that maintains mechanical capture. This is usually about 10% above threshold. Threshold is the minimum current that must be exceeded to begin producing a given effect, in this case ventricular capture. Typical threshold currents are between 40 and 80 mA. Location of the MFE Pads affects the current required to obtain ventricular capture. The MFE Pad placement that offers the most direct current pathway to the heart while avoiding large chest muscles usually produces the lowest threshold. Low stimulation currents produce less skeletal muscle contraction and are better tolerated.

Checking Underlying Patient Rhythm with 4:1 Mode

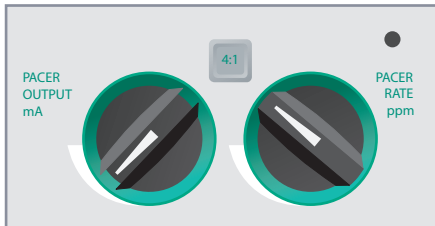

Press and hold the **4:1** button to temporarily withhold pacing stimuli thereby allowing you to observe the patient’s underlying rhythm and morphology. When depressed, this button causes pacing stimuli to be delivered at ¼ the indicated ppm setting.

Clearing Pacing Alarms

The messages *CHECK PADS* and *POOR PAD CONTACT* are alternately displayed on the screen and an audible alarm sounds if the unit is attempting to deliver pacing therapy and one of the following conditions is true:

- The MFE cable is not connected to the device.

- The MFE cable is defective.
- MFE Pads are not connected to the Multi-Function cable.
- MFE Pads are not making good skin contact.

The alarm continues to sound until the **Clear Pace Alarm** softkey is pressed.

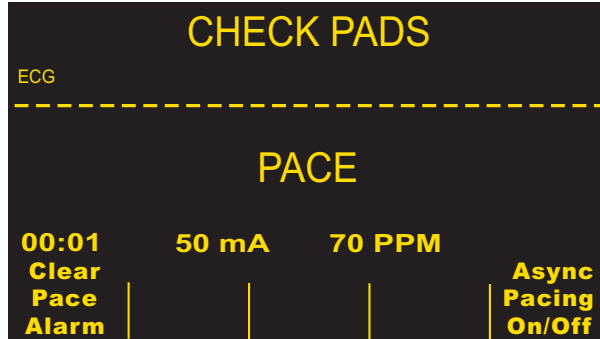

Special Pacing Applications

Noninvasive Temporary Pacing may be performed in the Cardiac Cath Lab, either for emergency pacing or in standby mode. Radiolucent stat-padz are available to facilitate pacing in X-ray and fluoroscopic applications.

Noninvasive Temporary Pacing may also be performed in the operating room using sterile stat-padz.



Observe the device carefully for evidence of proper operation.

Standby Pacing

For certain patients at risk of developing symptomatic bradycardia, it may be advisable to use the unit in standby mode. When used in standby mode, the unit automatically provides a pacing stimulus whenever the patient’s heart rate drops below a predetermined level. Patient’s ECG must be monitored using ECG leads and patient cables for this application. To use the device in standby mode:

1. Establish effective pacing (see instructions on previous pages). Note the mA output at capture and run an ECG strip to document ECG morphology during capture.
2. Set the mA output 10% higher than the minimum mA output necessary to effect consistent ventricular capture.
3. Turn the pacing rate (ppm) below the patient’s heart rate. This suppresses pacing unless the patient’s own

rate drops below the set pacing rate. The pacing rate should be set at a level sufficient for adequate cardiac output.

4. Check the threshold periodically.

Asynchronous Pacing

If ECG electrodes are not available or there is some circumstance that prevents or interferes with the surface ECG, it may be necessary to operate the pacemaker asynchronously.

Perform asynchronous pacing only in emergency situations when there are no other alternatives.

To pace asynchronously:

1. Press the **Async Pacing On/Off** Softkey.
The display shows the *ASYNC PACE* message to indicate that asynchronous pacing has been activated. The annotation "ASYNC PACE" is printed on the stripchart when activated by the **RECORDER** button. This annotation is also printed on the corresponding summary report.
2. To return to demand pacing, press the **Async Pacing On/off** softkey again and the display returns to PACE.

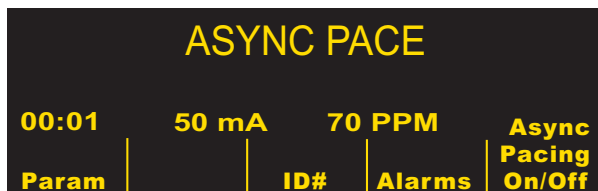

Pace stimuli is also delivered asynchronously whenever there is an ECG LEAD OFF condition. Be aware that there is no ECG activity on the display when pacing by this method; you must use other means of determining capture such as checking the patient's pulse. When pacing asynchronously with an ECG LEAD OFF condition, set the rate and mA at the known capture level or high enough (100mA) to presume capture.

Pediatric Pacing

Noninvasive pacing of pediatric patients is done in an identical manner to adult pacing. Smaller size pediatric MFE Pads are available for patients weighing less than 33 lbs/15 kg. Continuous pacing of neonates can cause skin burns. If it is necessary to pace for more than 30 minutes, periodic inspection of the underlying skin is strongly advised. Carefully follow all instructions provided on electrode package.

Troubleshooting

If your E Series unit does not function as expected, see the troubleshooting section "Pacer (Pacer version only)" on page 13-4.

SECTION 10

ECG MONITORING



ECG leads are a defibrillation-protected Type CF patient connection.

Introduction

You can use the E Series products for either short-term or long-term ECG monitoring.

E Series products have built-in protection circuitry to prevent damage to their ECG monitoring circuits during defibrillation attempts. Monitoring electrodes may become polarized during defibrillator discharge, causing the ECG waveform to briefly go off screen. High quality silver/ silver chloride (Ag/AgCl) electrodes minimize this effect, and circuitry in the instrument returns the trace to the monitor display within a few seconds.

ECG monitoring may be accomplished through an ECG patient cable, Multi-Function Pads or through standard defibrillation paddles. Use of an ECG patient cable and electrodes is required, however, to monitor during pacing.

You can use a 3-lead or 5-lead wire configuration for ECG monitoring. You can also view a summary of vital sign trends if the unit is configured with other physiological monitoring parameters, such as pulse oximetry (SpO₂) or end tidal carbon dioxide (EtCO₂).

Preparations

Proper application and placement of electrodes is essential for high quality ECG monitoring. Good contact between the electrode and skin minimizes motion artifact and signal interference.

Electrode Placement

Depending upon local usage, the ECG leads are marked either RA, LA, LL, RL, and V or R, L, F, N and C. The following table shows the markings and color codes for the different lead sets.

IEC Color Coding	AHA Color Coding	Placement of Electrodes
R/Red Electrode	RA/White Electrode	Place near patient's right mid-clavicular line, directly below clavicle.
L/Yellow Electrode	LA/Black Electrode	Place near patient's left mid-clavicular line, directly below clavicle.
F/Green Electrode	LL/Red Electrode	Place between 6th and 7th intercostal space on patient's left mid-clavicular line.
N/Black* Electrode	RL/Green* Electrode	Place between 6th and 7th intercostal space on patient's right mid-clavicular line.
C/White* Electrode	V/Brown* Electrode	Single movable chest electrode.

* Not used for 3-lead monitoring

For information on precordial lead placement (V1 - V6), see the *12 Lead Monitoring Operators Guide Insert*.

3-lead configuration

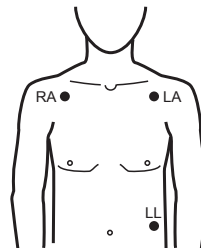

5-lead wire configuration

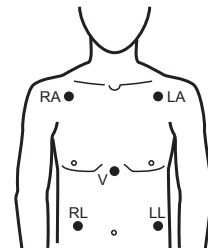

Monitoring Electrodes Attachment

Attach snap-on leads to electrodes and check for good contact between the electrode and the lead termination.

Peel the protective backing from the ECG electrode. Be careful to keep adhesive surface free of electrolyte gel.

CAUTION

Only use electrodes that are well within the expiration date indicated on the package.

Apply the ECG electrodes firmly to the patient's skin, pressing around the entire perimeter of the electrodes.

Plug the patient cable connector into the ECG input connector (located on the rear panel of the instrument).

CAUTION

To avoid electrosurgery burns at monitoring sites, ensure proper connection of the electrosurgery return circuit so that the return paths cannot be made through monitoring electrodes or probes.

During electrosurgery, observe the following guidelines to minimize ESU interference and provide maximum user and patient safety:

- Keep all patient monitoring cables away from earth ground, ESU knives, and ESU return wires.
- Use electrosurgical grounding pads with the largest practical contact area.

Always assure proper application of the electrosurgical return electrode to the patient.

Control Setting

Set selector switch to the MONITOR position.

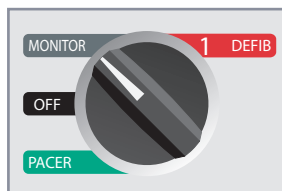

Press the **LEAD** button until the desired lead configuration is selected. The selected lead is indicated at upper right of display.



If the unit displays the *ECG LEAD OFF*, *CHECK PADS*, *POOR LEAD CONTACT*, or *POOR PAD CONTACT* message, inspect the ECG electrodes or MFE pads, lead wires, and associated connections.

If heart rate alarms are enabled with paddles selected, the unit displays the message *SELECT LIMB LEADS*. If you see this message, select limb or precordial leads.

If you want to change the size of the displayed ECG waveform, press the **SIZE** button until the desired waveform size is displayed. Options are 0.5, 1, 1.5, 2, and 3 times the normal size.

If you want to shut off the heart rate beeper, press the **Volume** softkey, then the **Dec** softkey repeatedly until you get to the lowest level. To turn it back on, press the **Inc** softkey

WARNING

Implanted pacemakers may cause the heart rate meter to count the pacemaker rate during incidents of cardiac arrest or other arrhythmias. Pacemaker patients should be carefully observed. Check the patient's pulse; do not rely solely on heart rate meters. Dedicated pacemaker detection circuitry may not detect all implanted pacemaker spikes; patient history and physical exam are important in determining the presence of an implanted pacemaker.

Spikes from Implanted Pacemakers

The device is capable of detecting pacemaker signals from a patient with an implanted pacemaker and indicates the signal on the display.

The device displays a thin, solid line on the ECG trace whenever it detects a pacemaker signal. The waveform spike produced by the pacemaker is displayed whether the pacer is atrial, ventricular, or both.

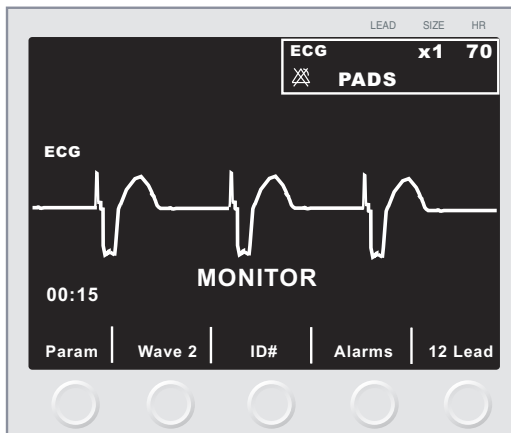

If you want to disable pacer detect:

1. Press the **Param** softkey.
2. Select ECG.
3. Press the **Disable Pacer Detect** softkey.

Alarms

WARNING
Heart rate alarms are non-operational when the AED unit is in semi-automatic mode.

Setting Alarm Limits

Unless configured otherwise, heart rate alarms are preset at 30 bpm (bradycardia) and 150 bpm (tachycardia). Refer to the E Series Configuration Guide for details on setting power-up alarm limits.

To set alarms:

1. Press the **Alarms** softkey to view the Alarm Set screen and softkeys.
2. Press the **Select Param** softkey.

This scrolls the highlighted area among the different possible vital signs.

Parameter	State	Low	High
ECG HR	ENABLE	30	150
SYSTOLIC	ENABLE	60	160
DIASTOLIC	ENABLE	50	110
MEAN	ENABLE	60	130
MORE			

Select Param	Inc >	Dec <	Next Field	Return
--------------	-------	-------	------------	--------

3. Press the **Inc** or **Dec** softkeys to select ENABLE, DISABLE, or AUTO in the State field.
 - If you press the **Next Field** softkey after selecting either ENABLE or DISABLE, the unit sets the

selected State value and moves the highlight to the next field on the right (Low limit field).

- If you press the **Next Field** softkey after selecting AUTO, the unit sets the lower and upper limits to 80% and 120% of the patient's currently measured heart rate if valid measurements are present for the vital sign. (Refer to appropriate Operator's Guide parameter insert(s) for percentages associated with other parameters). The highlight shifts to the next parameter field.

Note: To recalculate the Low and High limits for any parameter when these limits have previously been set using the AUTO State, press the **Inc** or **Dec** softkeys until AUTO is selected again and then press the **Next Field** softkey. The unit automatically resets the Low and High limits based upon the currently measured value of the selected physiological parameter.

4. If you did not select AUTO, press the **Inc** or **Dec** softkeys to set the Low alarm limit value, then press the **Next Field** softkey to confirm the selected value and move the highlight to the next setting field to the right (High limit field).

Repeat this step for the High limit field.

5. Press the **Return** softkey to set all values and return to normal operating mode.

Vital Sign Alarms

Each vital sign has an associated alarm with a high and low limit. You can set alarm limits for patient heart rate and other optional monitoring parameters such as pulse oximetry (SpO₂) if available.

The E Series unit has three levels of alarms as follows:

- **High Priority** — Reflects physiological parameters that are out of bounds. When these alerts occur, the unit emits a continuous audio tone, highlights the alarming parameter, and flashes the associated alarm symbol.
- **Medium Priority** — Reflects equipment-related, user correctable faults such as *LEAD OFF* and *CHECK SPO2 SENSOR*. The unit emits a two beep audio tone and displays a message for a timed period.
- **Low Priority** — Informational message only; the unit emits a two beep audio tone and displays a message for a timed period.

Heart Rate Alarm Limits

The heart rate is displayed in the upper right-hand corner of the screen, above the heart symbol.

Unless configured otherwise, heart rate alarms are preset at 30 bpm (bradycardia) and 150 bpm (tachycardia). The low heart rate alarm limit range is 20 bpm to 100 bpm.

When the unit is monitoring a patient's heart rate through ECG, the range for the high heart rate alarm is 60 to

280 bpm with a default setting of 150 bpm. When the unit is monitoring a patient's heart rate through pulse oximetry (SpO₂), however, the unit automatically lowers the upper limit for the high heart rate alarm to 235 bpm. The unit restores the original high heart rate alarm limit when ECG monitoring resumes.

Suspending and Silencing Alarms

When a high priority alarm occurs, the unit emits a continuous alarm tone, highlights the value of the alarming parameter on the display screen, and flashes the alarm symbol associated with that parameter.

You can either suspend the alarm tone for 90 seconds or you can silence the alarm tone.

Suspending Alarm Tones



To suspend the alarm tone for 90 seconds, *press and release* the **ALARM SUSPEND** button *in less than 1 second*. The alarm tone stops, the unit displays an "X" across the alarm's flashing alarm symbol, and the value of the alarming parameter remains highlighted. (If you press the **ALARM SUSPEND** button again, alarm processing is reactivated.)



After 90 seconds, if the physiological parameter remains at a value that triggers the alarm, the unit sounds the alarm tone again.

If the alarm condition clears (the physiological parameter returns to a value within range) after you have suspended the alarm tone, the unit resets the alarm and displays the alarm symbol (no flashing, no "X"). The alarm parameter displays normally (no highlighting).

If a second, different alarm occurs after you suspend an alarm tone, you can suspend the alarm tone for that second parameter by pressing and releasing the **ALARM SUSPEND** button. The unit performs the same way as described previously for the first alarm.

Silencing Alarm Tones



To silence the alarm tone, *press and hold down* the **ALARM SUSPEND** button *for between 1 and 3 seconds* (hold down button for at least one second, but less than 3 seconds). The alarm tone stops, the unit displays the alarm's alarm symbol with a dashed line "X" across it, and the value of the alarm parameter remains highlighted. (If you press the **ALARM SUSPEND** button again, alarm processing is reactivated.)



The alarm tone does not sound again as long as the physiological parameter's value remains out of range.

If the alarm condition clears (the physiological parameter returns to a value within range) after you silence the alarm tone, the unit resets the alarm and displays the alarm symbol (no inverse video, no "X"). The alarm parameter value displays normally (no highlighting).



After the unit resets an alarm, should the physiological parameter again go out of range, it triggers the alarm.

Deactivating and Activating Alarms

To deactivate all alarms on the E Series unit, *press and hold down* the **ALARM SUSPEND** button *for 3 seconds or longer*. The alarm symbol for all alarms has an "X" through them to indicate that the alarms are deactivated. Alarm parameter values display normally (no highlighting).

To reactivate the alarms, *press and release* the **ALARM SUSPEND** button *in less than 1 second*.

Smart Alarms

In Defib, Monitor or ON mode, ECG/heart rate alarm capabilities are enhanced with the defibrillation advisory feature called Smart Alarms™. When alarms are operating, this feature triggers an audible alarm whenever the unit detects ventricular fibrillation or wide complex ventricular tachycardias. For advisory-triggered alarms, an additional *CHECK PATIENT* message appears on the display and the chart recorder print out.

If alarms are operating in Pacer mode (Pacer version only), the unit displays the message *VF ALARMS OFF* indicating that the Smart Alarms™ feature has been disabled.

Recorder Operation

The stripchart recorder documents the ECG trace with a 6 second delay at all times. To start the stripchart recorder, press the **RECORDER** button. The stripchart recorder runs continuously until you press the button again.

Each time the strip recorder is started, the time, date, ECG lead, size, and heart rate are printed on the top part of the paper. If the unit is pacing, the output current is also printed. Similarly, if the defibrillator has been discharged, the delivered energy is printed.

Note: Check the paper supply at the beginning of each shift and after each use to ensure adequate recording capability. A colored stripe on the paper means that the paper supply is low.

A *CHECK RECORDER* message appears on the display when the stripchart recorder is activated without paper. The stripchart recorder automatically shuts off when there is no paper.

After loading new paper, press the **RECORDER** button to start the strip recorder.

Diagnostic Bandwidth

When using an ECG cable for monitoring, you can switch the unit to diagnostic bandwidth (0.05-150 Hz) by pressing and holding the **RECORDER** button depressed. Diagnostic bandwidth is maintained as long as the **RECORDER** button is held down. The unit reverts to

standard monitoring bandwidth when you release the **RECORDER** button.

5-Lead Monitoring

You can perform 5-lead ECG monitoring with the appropriate ECG patient cable. The 5-lead wire cable provides the following ECG monitor leads:

- I, II, III
- aVL, aVR, aVF
- V1

The Smart Alarms feature is always disabled during monitoring when augmented leads (aVR, aVF, aVL) or V-leads are selected. The messages *VF ALARMS OFF* and *SELECT LIMB LEADS* are alternately displayed when alarms are activated and augmented leads or V-leads are selected. These messages are displayed only the first time you select the augmented or V-leads. They are not redisplayed as you cycle through the lead selection.

Changing from 3-Lead Monitoring

To change from 3-lead to 5-lead monitoring, simply disconnect the 3-Lead ECG patient cable and connect the 5-lead wire ECG patient cable. Refer to the beginning of this section for appropriate preparations (i.e., placing electrodes, attaching electrodes, setting the controls, etc.) to be considered before performing five (5) lead monitoring.

If any ECG lead becomes disconnected during monitoring an *ECG LEAD OFF* message appears on the display.

Changing from 5-Lead ECG Monitoring

To change from 5-lead monitoring to 3-lead monitoring, you must power off the unit for at least 10 seconds, remove the 5-lead wire cable, connect the 3-lead cable, then power on the unit again. If you fail to shut the unit off for 10 seconds, the unit displays the *ECG LEAD OFF* message after you disconnect the 5-lead wire cable, even if leads are properly attached to the patient.

Simultaneous 3-Lead Printing

You can print 3 separate lead views of the patient ECG when using a 5-lead wire and the "Print 3 Leads When Leads are Sel" option is enabled in System Configuration.

The lead selection shown on the display is always the top ECG printed on the recorder strip. Signals simultaneously recorded by the other leads of each triplet (limb leads, augmented leads, etc.) are printed below this trace. For example, if aVR is selected, the recorder simultaneously prints aVR (top) followed by aVL (middle) and aVF (bottom). With 5-lead monitoring, the unit prints lead views for leads II, III, and aVF together when the "Custom Five Wire Grouping in Use" option is

set to Yes in System Configuration. Refer to the E Series Configuration Guide for more information.

Vital Signs Trending

Some E Series units include a vital signs trending feature that samples the instantaneous values of monitored physiological parameters and stores the sampled data in a log that includes the time these values were recorded. Vital signs include:

- Heart rate
- Pulse oximetry (SpO₂)
- End tidal carbon dioxide (EtCO₂)
- Respiration Rate
- Noninvasive blood pressure (NIBP) values.

You can view stored trend data in tabular form on the E Series display, or you can print it on the unit's stripchart recorder.

With trending enabled, the values of monitored vital signs are sampled once every 30 seconds and stored in the unit's trend memory. Trend memory stores up to 24 hours of 30 second trend records. When this storage is filled, the newest trending sample replaces the oldest trending sample.

The unit stores additional trend records whenever the unit raises a high priority vital signs alarm or when an additional NIBP measurement is taken. These additional records decrease the overall number of 30 second trend records that can be stored in the unit's memory.

Viewing Vital Signs Trending Data on the Display

The display for vital signs trending data always shows the time of the recorded data, the heart rate/pulse rate and the SpO₂. The date of the recording appears at the top of the trend display. EtCO₂ and NIBP are optionally displayed based on the configuration of the unit.

To select either EtCO₂ or NIBP data for viewing:

1. Press the **SUMMARY** button.
2. Press the **Trend** softkey on the Summary menu.
3. Press the **Select** softkey to highlight either EtCO₂ or NIBP.
4. Press the **Enter** softkey to select the desired option.

To view only SpO₂ data when multiple parameters are installed, use the **Select** softkey to highlight SpO₂ from the Trend submenu, then press the **Enter** softkey.

If only one parameter is installed on the unit, the trend screen automatically appears when you press the **Trend** softkey.

09-Jun-10				
TIME	HR/PR	SpO2	CO2	
5 MIN			EtCO2	RR
13:35	120	100	4.1	36
13:30	119	100	4.3	13
13:25	120	99	3.7	15
13:20	119	99	3.7	15

Print | **Newer** | **Older** | **Zoom** | **Return**

Not all trending data can be displayed on the monitor at the same time. However, you can select the resolution of the time between samples by using the **Zoom** Softkey. You can view ALL trending data, or you can view trending data taken at 5 minute, 10 minute, 15 minute, 30 minute, and 60 minute intervals. Data is presented with the newest data at the top and the oldest data at the bottom of the display.

If an alarm occurs while the unit is monitoring vital signs, such as an NIBP alarm, the unit records the data at the moment of the alarm, independent of the standard 30 seconds interval recording.

The unit indicates an alarm condition on the trend display by highlighting the alarmed parameter on the display. The unit indicates invalid data by substituting a dashed line (---) for the actual data. Invalid data may occur, for example, when the measuring probe or device is not properly connected to the patient.

The most recently recorded trending sample is indicated by highlighting the time stamp associated with the trend data. If no time record is highlighted, older data is being displayed. To view the newest values of recorded data, press the **Newer** softkey until the highlighted time displays.

When viewing the newest data, the display automatically updates as each new trend record is recorded. To view older values of recorded data, press the **Older** softkey until the desired data displays. If you are viewing the most recent trending data, the trending screen remains displayed until you exit the screen. However, if you are viewing anything other than the most recent trending data, the trending screen times out three minutes after the last softkey activation.

Printing a Vital Signs Trend Report

The stripchart prints the trend report using the same zoom level that the display uses. If the Zoom setting is set to All and you press the **Print** softkey on the Trend display, all trending samples print from the starting record shown back through to the oldest record.

Data is printed on the stripchart in order of newest data to oldest data. Alarm conditions are indicated on the stripchart by placing brackets around alarmed values. As on the display, invalid data is indicated by a dashed line (---) for the actual data.

NIBP readings are considered valid for only one trend record (i.e., the sample during which the NIBP measurement was completed). All other trend records indicate invalid NIBP readings.

TREND REPORT (All)

09-JUN-05

DATE	TIME	HR/PR	SpO2	NIBP	M	EtCO2	RR
DD-MMM-YY	HH:MM		%	SYS	DIA	mmHg	
09-Jun-05	13:35:29	120	100	---	---	41	36
09-Jun-05	13:34:59	120	100	---	---	36	14
09-Jun-05	13:34:29	119	100	---	---	41	13
09-Jun-05	13:33:59	120	100	---	---	42	11
09-Jun-05	13:33:29	120	100	---	---	37	15
09-Jun-05	13:32:59	119	98	---	---	36	15
09-Jun-05	13:32:29	120	99	---	---	42	14
09-Jun-05	13:31:59	120	100	---	---	42	14
09-Jun-05	13:31:29	119	100	---	---	41	11
09-Jun-05	13:30:59	120	100	---	---	40	10

ZOLL:00000003-00.00-007B

ZOLL Medical Corporation | Recorder P/N: 8000-0300 | ZOLL Medical Corporation

If the Zoom setting is set to five minutes, when you press the **Print** softkey on the Trend display, a reports prints out that includes only the values sampled at the five minute intervals.

TREND REPORT (5 Min)

09-JUN-05

DATE	TIME	HR/PR	SpO2	NIBP	M	EtCO2	RR
DD-MMM-YY	HH:MM		%	SYS	DIA	mmHg	
09-Jun-05	13:35:29	120	100	---	---	41	36
09-Jun-05	13:30:29	119	100	---	---	43	13
09-Jun-05	13:25:29	120	99	---	---	37	15
09-Jun-05	13:20:29	60	100	---	---	37	10
09-Jun-05	13:15:29	60	100	---	---	39	12
09-Jun-05	13:10:29	60	100	---	---	41	18

REPORT COMPLETE

ZOLL:00000003-00.00-007B

ZOLL Medical Corporation | Recorder P/N: 8000-0300 | ZOLL Medical Corporation

NIBP Trend Operation

When displaying NIBP trends, only those trending samples recorded for NIBP readings are displayed. NIBP History trend reports contain all NIBP records regardless of the Zoom level.

9C105

NIBP HISTORY								
09-JUN-05								
DATE	TIME	HR/PR	SpO2	SVS	NIBP	M	EtCO2	RR
DD-MMM-YY	HH:MM		%		DIA		mmHg	
09-Jun-05	13:44:41	119	96	114	76	89	43	17
09-Jun-05	13:44:17	120	97	115	76	89	31	15
09-Jun-05	13:43:53	119	96	115	76	89	40	17
09-Jun-05	13:43:30	120	95	116	75	89	42	19
09-Jun-05	13:43:06	119	95	115	75	88	46	19
09-Jun-05	13:42:41	120	96	113	75	88	41	17
09-Jun-05	13:42:18	119	96	115	76	89	46	16
09-Jun-05	13:41:54	120	96	115	76	89	44	15
09-Jun-05	13:41:31	120	97	115	77	90	40	16
09-Jun-05	13:41:06	120	97	115	76	89	34	21

ZOLL:0000003-00.00-0078

ZOLL Medical Corporation Reorder P/N: 8000-0300 ZOLL Medical Corporation

Clearing Vital Signs Trend Records

The unit stores at least 24 hours of normal (non-alarmed, non-NIBP) trending samples before it is overwritten. If the unit is powered down while recording trend data, the corresponding gap in time is indicated on the display by a series of asterisks in the time field and no data points in any parameter fields. On the stripchart, this gap is indicated by several things: the annotation "POWER OFF DETECTED" is printed at the bottom of the display, the stripchart paper advances and a new page of trending data is started. If the unit is turned off for more than a user-specified length of time, all vital signs trend data is automatically erased.

To clear trend data, press and hold the **SUMMARY** button until the display shows the Erase Summary, Erase Trend and **Erase All** softkeys. Press the **Erase Trend** softkey. The *ERASING REPORT* message displays and the trend data is cleared.

If your unit does not function as expected, see "Troubleshooting Guidelines" on page 13-1.

(This page intentionally left blank.)

SECTION 11

GENERAL MAINTENANCE

Resuscitation equipment must be maintained to be ready for immediate use. Perform the following operational checks at the beginning of every shift to ensure proper equipment operation and patient safety.

Operator's Shift Checklists are included at the end of this section to aid in checking and maintaining the unit. Copy and distribute the appropriate sheet to all individuals responsible for the device's use and readiness.

Note: Self-test defibrillation and pacing data is automatically recorded on the PCMCIA data card, if present. You can configure the unit to erase all self-test data from the data card on power-off. See the E Series Configuration Guide for more information.

Inspection

When you visually inspect the E Series unit, check the items listed in steps 1 through 7 in the Operator's Shift Checklist.

Cleaning

E Series products and accessories are chemically resistant to most common cleaning solutions and non-caustic detergents. ZOLL recommends cleaning the device, paddles, and cables with a soft damp cloth, and the following cleaning agents:

- 90% isopropyl alcohol (except adapters and patient cable)
- Soap and water
- Chlorine bleach (30ml/l water)

The recorder parts should be cleaned with a damp, soft cloth only.

Do not immerse any part of the device or accessories (including paddles) in water. Do not use ketones (MEK, acetone, etc.). Avoid using abrasives (e.g., paper towels) on the display window. Do not sterilize the device.

Make sure to clean the defibrillation paddles after each use. Build up of gel interferes with paddle ECG monitoring and may produce a shock hazard to the operator. Keep paddle handles clean.

Cleaning the Recorder Printhead

To clean the recorder printhead, perform the following steps:

1. Open the recorder cover on top of the E Series unit.
2. Remove the paper (if necessary).
3. Locate the row of soft, thin bristles on the front edge of the paper compartment.
4. Locate a thin black line (printhead) adjacent and parallel to the bristles.
5. Gently wipe the thin black line with an alcohol (isopropyl) moistened Q-tip.
6. Dry any residual alcohol with a new Q-tip.
7. Reload the recorder with paper.

Testing the E Series Unit

The following sections cover testing of the:

- stripchart recorder
- Defibrillator (Semiautomatic mode)
- Defibrillator (Manual mode)
- Pacer (Pacer Version Only)

Testing the Stripchart Recorder

Follow these steps to test the stripchart recorder:

1. Check for adequate supply of paper.
2. Press the **RECORDER** button.

The stripchart recorder runs until the **RECORDER** button is pressed again.

Press and hold the **SIZE** button for at least 2 seconds to generate a calibration pulse.

The calibration pulse remains on the display for as long as the **SIZE** button remains depressed. In addition, the amplitude of the calibration pulse is 1 mV independent of the size setting.

3. Inspect the recorder waveform for uniformity and darkness, and the stripchart data for uniformity of annotation characters and completeness of words.
4. Verify that the calibration pulse is $2.5 \pm \frac{1}{2}$ mm wide and 10 ± 1 mm high.

Testing the Defibrillator (Semiautomatic Mode)

Perform these tests on all AED units periodically.

Power-Up Sequence Test

Follow these steps to verify the unit's power-up sequence.

1. Turn the selector switch on the front panel to the ON position
2. Verify the following:
 - The unit emits a 4-beep tone to indicate the power-up self test has been successfully completed.
 - The *CHECK PADS* message is displayed and announced.

Defibrillator Test

Perform the defibrillator test to verify that the unit analyzes ECG rhythm and delivers shock treatment correctly. To perform this test, you need an ECG rhythm simulator.

1. Ensure that the selector switch on the E Series front panel is in the OFF position.
2. Connect the patient end of the multifunction cable to the defibrillator test connector.
3. Turn the selector switch to ON.
4. Press the **ANALYZE** button and verify that the unit charges to 30 J (30 J READY message).
5. Once unit has charged, verify the **SHOCK** button illuminates.
6. Press and hold the **SHOCK** button.
7. Verify that the unit briefly displays the *TEST OK* message and prints a stripchart.

This message indicates that the unit delivered energy within specifications.

Note: If *TEST FAILED* message appears, contact the ZOLL Technical Service Department immediately.

8. Connect the multifunction cable to the ZOLL ECG Simulator, and set the simulator to VF.
9. Verify that within 30 seconds the unit displays and announces the *CHECK PATIENT* prompt.
10. Press the **ANALYZE** button on the front panel and verify the unit charges to 120 J or other preconfigured level.
11. Once unit has charged, verify that it illuminates the **SHOCK** button and that it displays and announces the *PRESS SHOCK* prompt.
12. Press and hold the **SHOCK** button and verify unit discharges.

Note: If a *LOW BATTERY* message appears during testing at the beginning of a shift, the battery currently in use is close to depletion; replace and charge the battery. The device does not test the battery for adequate charge to support extended use of the unit; capacity can only be determined by testing the battery in a Base Power Charger 4x4 or SurePower Charger.

Testing the Defibrillator (Manual Mode)

Perform these tests on all standard E Series units periodically.

Note: During the Energy Delivery Test, the unit discharges only when the energy level is set to 30 joules.

Power-Up Sequence Test

Follow these steps to verify the unit's power-up sequence. To perform this test, you need an ECG rhythm simulator.

1. Ensure the selector switch on the E Series front panel is set to OFF, and connect the ECG monitoring cable to the simulator.
2. Turn the selector switch to the MONITOR position.
3. Verify that the:
 - The unit emits a 4-beep tone to indicate the power-up self test has been successfully completed.
 - ECG size is x1
 - *MONITOR* message displays on the LCD
 - ECG source is PADDLES or PADS

If no ECG cable is connected to the simulator, the message *ECG LEAD OFF* is displayed and the ECG display shows a dashed line instead of a solid line.

Delivered Energy and Shock Buttons

Perform this test at the start of each shift.

WARNING

When performing this test using paddles, use your thumbs to operate the **SHOCK** buttons in order to avoid an inadvertent shock. No portion of the hand should be near the paddle plates.

Paddles Setup:

1. Verify adult paddles are installed and are inserted all the way into their holders on the side of the E Series unit.
2. Turn the selector switch to DEFIB.
3. Set the defibrillator energy level to 30 joules.
4. Press the **CHARGE** button on the apex handle and verify that the unit displays the *DEFIB 30J READY* message.

5. When charge ready tone sounds, use the defibrillator **ENERGY SELECT** buttons on either the sternum paddle or defibrillator front panel to change the selected energy to 20 joules.
6. Verify that the unit disarms itself.
7. Use the defibrillator **ENERGY SELECT** buttons on either the sternum paddle or defibrillator front panel to change the selected energy back to 30 joules.

MFC Setup:

1. Plug the MFC cable into the unit, making sure it is not plugged into the test connector.
2. Set the selector switch on the front panel to DEFIB and select 30 J.
3. Verify that the unit alternately displays the *CHECK PADS* and *POOR PAD CONTACT* messages.
4. Insert the end of the Multi-Function Cable into its test connector (Attached to the Multi-function cable), as shown below.

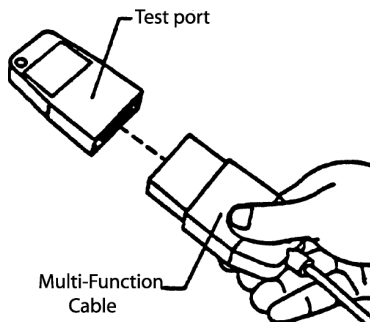

5. Verify that the unit displays the *DEFIB PAD SHORT* message.

Energy Delivery Test

1. Press the **CHARGE** button on the front panel.
2. Wait for the charge ready tone to sound and verify that the energy ready value displayed on the monitor registers 30 joules (*DEFIB 30J READY*).
3. Press and hold the **SHOCK** button on the front panel of the defibrillator (or the shock buttons on the paddles) until discharge occurs.
4. Verify that the units displays the *TEST OK* message and prints a stripchart of the event, noting the energy delivered and impedance data.

Note: If *TEST FAILED* appears, contact the ZOLL Technical Service Department immediately.

Testing the Pacer (Pacer Version Only)

Perform these tests on all pacer-equipped units periodically.

1. Connect the ECG leads and Multi-function cable to the simulator.
2. Turn the selector switch to PACER.
3. Turn the pacer rate control to 150 ppm.

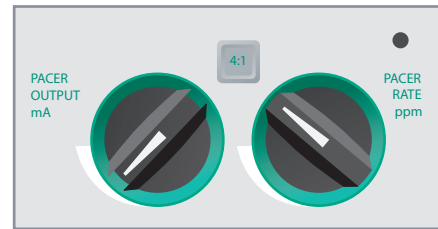

4. Press the **RECORDER** button to generate a strip, and then again to stop printing.
5. Verify that the pacing stimulus markers () occur approximately every 10 small divisions (2 large divisions or 1 cm).
6. Press the **RECORDER** button to generate another stripchart, then press and hold the **4:1** button on the front panel.
7. Press the **RECORDER** button again to stop printing.
8. Verify that the frequency of the markers decreases (8 large divisions or 4 cm between each marker).
9. Turn the PACER OUTPUT control to 0 mA.
10. Verify there are no *CHECK PADS* or *POOR PAD CONTACT* messages.
11. Disconnect MFE Pads or paddles from the Multi-Function cable, and slowly turn the knob up to change the pacer output to 16 mA.
12. Verify that the Pace alarm sounds and a *CLEAR PACE ALARM* prompt flashes.
13. Connect the Multi-Function cable to the test connector, and press the **Clear Pace Alarm** softkey.
14. Verify that the unit Pace alarm stops and that the unit removes error messages from the LCD.

Changing Recorder Paper

You should always check for adequate paper supply in the unit before operation. Failure to do so may result in insufficient paper to print out event information during clinical rescue.

Follow these steps to change the paper:

1. Open the recorder module on top of the E Series unit.
2. Remove the paper from the tray.
3. Unfold the top sheet of a pad of thermal paper.

You should *not* see a thick red line (which indicates the end of the pad). If you do, turn the pad over and unfold the top sheet

4. Align the paper above the open tray.

The proper orientation is with the black arrows pointing up, and the word "ZOLL Medical Corporation" running along the left side, as shown.

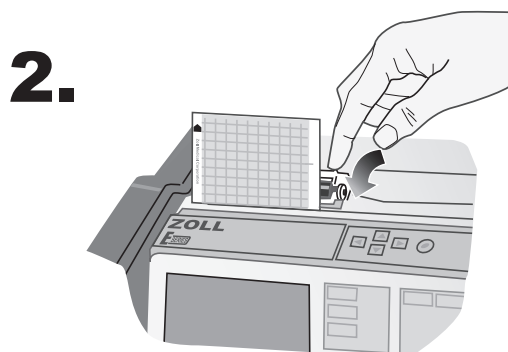
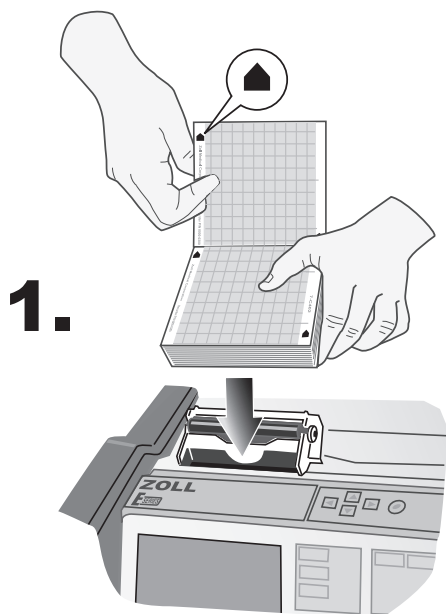

5. Slide the paper into the tray.

The paper should extend out of the stripchart recorder when the recorder door is closed.

6. Shut the recorder module, and press down on both sides of the door until you hear both sides click.

Note: It is important to close both sides of the door firmly, otherwise the paper may jam in the recorder.

Setting Time and Date

Check the time and date on the recorder annotation. If it is not correct, reset the time and date (from System Utilities mode) manually, by dial-up to a National Institute for Science and Technology (NIST) site, or using the GPS synchronization feature.

After implementing time reset using any of the methods described below, verify that the time and date are set correctly by pressing the **RECORDER** button to generate a stripchart recording. Check that the stripchart is correctly annotated with the current time and date, selected ECG size, source and heart rate.

Verify that the real-time clock is operating correctly by waiting for several minutes then running the stripchart recorder again.

Set the time on the unit at least once every 2 weeks to prevent significant discrepancies between the unit's time and standard Greenwich Mean Time (GMT).

Turn the selector switch to OFF. The device must remain off for at least 10 seconds before entering System Utilities mode.

Note: Time and date may require resetting if the device's internal battery is depleted or the time zone has changed.

Note: For both automated dial-up and GPS synchronization methods, the correct time zone and DST option must be set in System Configuration mode for the updated date and time to be correct.

Manual Method

1. Press and hold the left-most softkey on the unit while turning the selector switch to MONITOR (ON for AED units). When the "System Utilities" screen appears on the monitor, release the softkey.
2. Press the **MORE** softkey and then the **Clock Sync** softkey to display the set time option menu.
3. Press the **Manual Time Set** softkey to display the Set Time screen.

The month field will be highlighted.

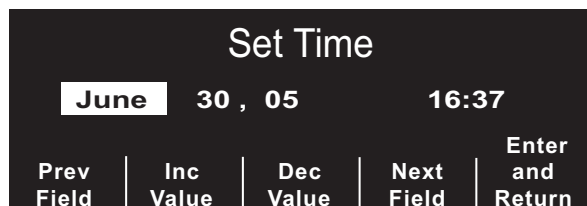

4. Press the **Inc Value** or **Dec Value** softkeys to select the appropriate month.
5. Press the **Next Field** softkey to set the selected month and move the highlight to the next field (day).
6. Repeat steps 4 and 5 to set the correct day, year, hours and minutes field.

Note: The last field does not automatically scroll (wrap) to the beginning. You must press the **Prev Field** softkey to enter the values for the last field.

If you need to make corrections, press the **Prev Field** softkey to move the highlight to the field previously entered.

7. Press the **Enter and Return** softkey to set all values and return to normal monitoring mode.

Note: Repeated display of the "SET CLOCK" or "CLOCK FAULT" message may indicate that the internal battery powering the unit's Real Time Clock is depleted. See the **Troubleshooting Guidelines** in Section 13 of this manual for more information.

Automated Dial-up Method

Note: To use this method, a modem connection is required.

1. Press and hold the left-most softkey on the unit while turning the selector switch to the MONITOR or ON position. When the System Utilities screen appears on the monitor, release the softkey.
2. Press the **MORE** softkey and then the **Clock Sync** softkey to display the set time option menu.
3. Press the **Dial Time Set** softkey. A setting screen appears, allowing the user to choose a NIST (National Institute for Science and Technology) dial location and a prefix for the phone number of the selected NIST location, as required. For example, if the NIST location is outside of the local calling area, users within the continental United States would enter a "1" as the dial prefix. Other users would enter a dial prefix as required for placing calls in the continental United States.
4. Press the **Dial** softkey.

The word "Initializing" appears briefly, followed by the Clock Synchronization screen, displaying the user configurable NIST phone number with the appropriate prefix. The word "Dialing" appears underneath, along with a seconds counter, as the unit connects to the NIST site.

After receiving the atomic clock information from the NIST site, the unit then displays updated date and time information, unless one of the following errors occurs:

Error Message	Description/Corrective Action
<i>MODEM REQUIRED</i>	The unit determined that there is no modem card installed. Install a supported modem card and retry.
<i>MODEM INIT ERROR</i>	The modem could not be initialized. Replace the modem card and retry.
<i>NO DIALTONE</i>	The unit could not detect a dial tone. Check the connection between the modem and the phone jack, or try a different phone line.

Error Message	Description/Corrective Action
<i>BUSY</i>	The unit detected a busy signal from the selected NIST location. Retry.
<i>NO ANSWER</i>	The unit received no answer from the selected NIST location. Retry or select another NIST location.
<i>NO CARRIER</i>	The unit determined that the line is broken. Correct the line break and retry.
<i>HANG UP</i>	The unit received a hang up indication from the selected NIST location. Retry.
<i>MODEM DIAL ERROR</i>	The modem could not dial the phone number. Ensure that the modem card is properly connected. Ensure that the user-selected dial prefix is correct. (Refer to <i>E Series Configuration Guide</i> for information). Retry.
<i>NIST DATA ERROR</i>	The unit detected an error in the data from NIST. Retry.

displayed. Press the **Return** softkey to return to the Main System Utilities screen.

Note: GPS synchronization works best when the unit has a direct line of sight to GPS satellites. Placing the unit outdoors or adjacent to an unblocked window when performing GPS synchronization is advised.

GPS Synchronization

1. Press and hold the left-most softkey on the unit while turning the selector switch to MONITOR (ON for AED units). When the System Utilities screen appears on the monitor, release the softkey.
2. Press the **MORE** softkey and then the **Clock Sync** softkey to display the set time option menu.
3. Press the **GPS Time Set** softkey to display the GPS Clock Synchronization screen.

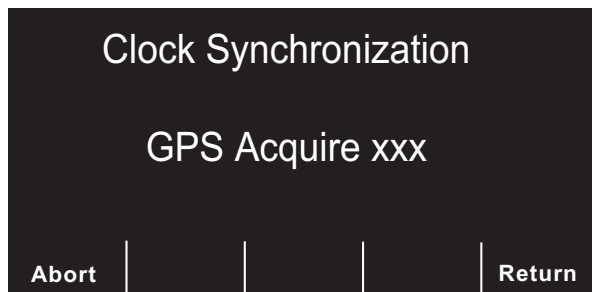

When the GPS time has been acquired, the display shows the acquired date, time, day and the number of seconds required to sync the clock. Latitude and longitude may also be displayed if a complete satellite fix was obtained. If a partial satellite fix was used to obtain the clock information, the latitude and longitude will not be displayed. Press the **Return** softkey to store the acquired time and return to the Main System Utilities screen.

Pressing the **Abort** softkey cancels the GPS synchronization; the message GPS ABANDONED is

Operator's Shift Checklist for E Series Products (Manual)

Recommended checks and procedures to be performed at the start of each shift. For more detailed information, see the E Series Operator's Guide.

Date	Location	Unit Serial Number			Remarks
1. Condition		1st Shift	2nd Shift	3rd Shift	
Unit clean, no spills, clear of objects on top, case intact					
2. Multi-function Pads					
1 set preconnected / 1 spare (check expiration dates)					
3. Paddles					
Paddles clean, free of gel and contaminants, not pitted					
Release from paddle wells easily					
4. Inspect cables for cracks, frays, broken wires, connector pins					
A. ECG electrode cable, connector					
B. Defibrillator paddle cables, paddle handle					
C. Multi-function cable, connector					
5. Batteries					
A. Fully charged battery in unit					
B Fully charged spare battery available.					
6. Disposable supplies					
A. Electrode gel or gel patches					
B. MFE Pads in sealed pouches — 2 sets					
C. ECG electrodes					
D. Recorder paper					
E. Alcohol wipes					
F. Razors					
7. Memory Card					
Empty memory card install in unit (if applicable)					
8. Operational checks					
A. Power On Sequence					
Turn unit to MONITOR, 4-beep tone heard					
MONITOR message on display					
ECG size X 1					
PADDLES or PADS as lead selected					
B. Pacer Operation (Pacer version only)					
Multi-function cable not connected to Test Connector					
Turn to PACER, set pacer rate to 150 ppm, press RECORDER button					
Pacer pulses occur ever 2 large divisions (10 small divisions)					
Press 4:1 button, pulses occur every 8 large divisions					
Set PACER OUTPUT to 0 mA, no CHECK PADS prompt					
Set PACER OUTPUT to 16 mA, CHECK PADS prompt and alarm					
Reconnect Multi-function cable to test connector.					
Press Clear Pace Alarm softkey; CHECK PADS prompt disappears and Pace alarm stops.					
C. Defibrillator					
Multi-function cable connected to test connector: Set defib energy level to 30 joules, press SHOCK button; TEST OK message on Recorder					
D. Paddles					
Paddles in holders: Set defib energy level to 30 joules, and simultaneously press and hold both paddle SHOCK buttons; TEST OK message on Recorder.					
E. Recorder					
Press RECORDER button; recorder runs. Press again; recorder stops.					
Inspect recorder printout					
9. Please check the appropriate box after each use of this checklist.					Signatures
No action required					1st _____
Minor problem(s) corrected					2nd _____
Disposable supplies replaced					3rd _____
Major problem(s) identified — UNIT OUT OF SERVICE					

Operator's Shift Checklist for E Series Products (Semiautomatic)

Recommended checks and procedures to be performed at the start of each shift. For more detailed information, see the E Series Operator's Guide.

Date _____ Location _____ Unit Serial Number _____

1. Condition	Unit Serial Number			Remarks
	1st Shift	2nd Shift	3rd Shift	
Unit clean, no spills, clear of objects on top, case intact				
2. Multi-function Pads				
1 set preconnected / 1 spare (check expiration dates)				
3. Paddles (if applicable)				
Paddles clean, free of gel and contaminants, not pitted				
Release from paddle wells easily				
4. Inspect cables for cracks, frays, broken wires, connector pins				
A. ECG electrode cable, connector				
B. Defibrillator paddle cables, paddle handle				
C. Multi-function cable, connector				
5. Batteries				
A. Fully charged battery in unit				
B. Fully charged spare battery available				
6. Disposable supplies				
A. Electrode gel or gel patches				
B. MFE Pads in sealed pouches — 2 sets				
C. ECG electrodes				
D. Recorder paper				
E. Alcohol wipes				
F. Razors				
7. Memory Card				
Empty memory card install in unit (if applicable)				
8. Operational checks				
A. Power On Sequence				
Turn unit to ON, 4-beep tone heard				
B. Defibrillator				
Multi-function cable connected to test connector: <i>CHECK PADS</i> displays.				
Press ANALYZE button, unit charges to 30 J				
Press and hold SHOCK button, <i>TEST OK</i> is displayed and printed				
Attach MFC to ECG Simulator, set to VF				
Verify <i>CHECK PATIENT</i> prompt is displayed				
Press ANALYZE. Verify unit charges to 120 J				
Press SHOCK, verify shock was delivered.				
C. Paddles (if applicable) (Manual mode only)				
Paddles in holders: Set defib energy level to 30 joules, and simultaneously press and hold both defib discharge buttons; <i>TEST OK</i> message on recorder.				
D. Pacer Operation (Manual mode only)				
Multi-function cable not connected to Test Connector				
Turn to PACER, set pacer rate to 150 ppm, press RECORDER button				
Pacer pulses occur ever 2 large divisions (10 small divisions)				
Press 4:1 button, pulses occur every 8 large divisions				
Set PACER OUTPUT to 0 mA, no <i>CHECK PADS</i> prompt				
Set PACER OUTPUT to 16 mA, <i>CHECK PADS</i> prompt and alarm				
Reconnect Multi-function cable to test connector.				
Press Clear Pace Alarm softkey; <i>CHECK PADS</i> prompt disappears and Pace alarm stops.				
E. Recorder				
Press RECORDER button; recorder runs. Press again; recorder stops.				
Inspect recorder printout				
9. Please check the appropriate box after each use of this checklist.				Signatures
No action required				1st _____
Minor problem(s) corrected				2nd _____
Disposable supplies replaced				3rd _____
Major problem(s) identified — UNIT OUT OF SERVICE				

SECTION 12

BATTERY MANAGEMENT

Battery Care

Safe, reliable use of the system requires a well designed battery management program to ensure that adequate battery power is always available.

ZOLL has developed the *ZOLL Battery Management Program* booklet (9650-0019-01), and the *ZOLL SurePower defibrillator battery Operator's Manual* (9650-0536-01). They include information for determining your particular battery requirements and program implementation steps to set up a comprehensive, effective, and safe program.

For safe disposal of batteries and disposable electrodes, follow your national, state, and local regulations. In addition, to prevent risk of fire or explosion, never dispose of the battery in a fire.

Battery Life Expectancy

Lead acid battery packs require full recharging after use. Repeated short cycle recharging results in reduced capacity and early battery pack failure.

WARNING

Regular use of partially charged lead acid battery packs without fully recharging between uses results in permanently reduced capacity and early battery pack failure.

Frequency of use, number of batteries used for operation, and the pattern of discharging and recharging batteries contribute to the loss of battery charge capacity. Because of this, ZOLL recommends that operators replace and discard used batteries on a preventive, scheduled basis. The most effective preventive replacement interval should be based on anticipated use patterns, battery pack testing results and experience with the device in actual operation.

ZOLL recommends battery replacement every 18 months or sooner.

LOW BATTERY Message

Whenever the unit detects a low battery condition, a *LOW BATTERY* message is displayed on the monitor once every minute, and a 2-beep low battery tone sounds once every minute or once every 5 minutes. The tone emission and frequency are configurable options that you can set in the System Configuration screen.

This message and beeping persists until just before device shutdown when the unit beeps twice and the *REPLACE BATTERY* prompt appears for approximately 20 seconds.

WARNING

Test batteries regularly. Batteries that do not pass ZOLL's capacity test could unexpectedly shutdown without warning.

As individual battery capacity diminishes, the amount of operating time remaining after a *LOW BATTERY* message also diminishes. For newer or lesser-used batteries, the operating time remaining after this warning is significantly longer than the operating time remaining with batteries having seen more use. In either case, this warning ultimately leads to defibrillator shut-off. Replace the battery with a fully-charged battery immediately after the *LOW BATTERY* or *REPLACE BATTERY* prompt appears.

Changing the Battery Pack

The E Series products are designed for quick removal and replacement of the battery pack.

To remove the battery pack:

1. Turn the unit off.
2. Insert a finger into the recess at the left end of the battery pack, and press it against the battery pack to disengage the battery pack locking clip.
3. Lift the battery pack out.

To install a battery pack

1. Align the tab of the battery pack case with the battery pack removal finger recess on the top of the unit.
2. Set the battery pack into the battery pack well.

The shape of the battery pack allows the battery pack to seat itself.

- Turn the defibrillator back on to the selected mode of operation.

Note: If a battery has been discharged below its safe limit (8.5 V), which could occur during long-term storage, the battery fault indicator illuminates when it is installed. In this case, the battery is not usable; remove it immediately. Replace with a fully-charged battery. (In emergency situations, you can use AC power.)

If the unit is set to PACER mode, pacing may resume immediately after battery replacement. If this is not desired, then turn the unit off for more than 10 seconds prior to replacing the battery.

When operation of the unit is resumed subsequent to battery replacement, you must re-verify the unit's settings (for example, alarms, lead, pacing amplitude and rate).

Charging and Testing Battery Packs

ZOLL batteries are designed to be charged in the E Series device or accessory chargers designed for use with ZOLL devices. ZOLL recommends that you always have a ZOLL auxiliary battery charger available in order to charge spare batteries and perform periodic battery testing; the ZOLL Base Power Charger 4x4 or SurePower Charger was designed specifically for this purpose.

With the E Series unit plugged in to AC mains and turned off, the device recharges the sealed lead acid battery to greater than 90% capacity within 4 hours, and the lithium-ion battery pack to greater than 90% capacity in less than 7 hours. With the E Series unit plugged in and in use, the device recharges a fully depleted sealed lead acid battery, or lithium-ion battery pack within 24 hours.

When the E Series products are plugged into AC mains, the CHARGER ON indicators operate in the following manner:

- The orange-yellow CHARGER ON indicator illuminates continuously whenever the device is turned OFF and charging the battery or turned ON with a battery installed.
- The green CHARGER ON indicator illuminates continuously whenever the unit is turned OFF and the installed battery has been fully charged to present capacity.
- The green and orange-yellow CHARGER ON indicators illuminate alternately when no battery is installed in the unit, or when a battery charging fault has been detected.

When the device is not connected to AC mains, the CHARGER ON indicators remain extinguished.

Top Panel Battery LEDs

The top panel of the unit contains 4 LEDs to indicate the battery charge level and 1 LED to indicate a battery fault. These LEDs are active only if a SurePower battery is

installed in the unit. If a fault is detected in the battery, the fault LED is illuminated and the battery charge level LEDs are turned off. If the fault LED is not illuminated, the battery charge level LEDs are illuminated as follows:

Number of LEDs Lit	Indicates Remaining Runtime of:
4	> 90 minutes
3	> 60 minutes
2	> 30 minutes
1	> 15 minutes
0	≤ 15 minutes

Troubleshooting

If your E Series unit displays a *BATTERY FAULT XX* message, a battery-related fault condition has occurred. Attempt to clear the fault by removing and reinstalling the battery pack. Replace the battery and contact the ZOLL Technical Service department if the condition persists.

Achieving Optimal Battery Pack Performance

The following general practices will ensure the longest life from your battery pack:

“Do’s and Don’ts” in using battery packs:

- **DO charge battery packs completely.**

When a battery pack exchange is required, place a fully charged battery in the unit.

If you use a partially charged battery pack, it may result in a very short monitor/defibrillator run time.

If a partially charged battery pack is used, a full charge is recommended before its next use. Repeated use after partial charging quickly diminishes the battery pack’s capacity, thereby shortening its life.

Frequent use of partially charged batteries requires reassessment as to whether enough battery packs are in service.

- **DO change Battery Packs when LOW BATTERY warning message appears.**

The LOW BATTERY warning ultimately leads to monitor/ defibrillator shut down. As batteries age, the run time between the LOW BATTERY warning and monitor/ defibrillator shut down progressively diminishes. Older batteries may provide very little run time between the LOW BATTERY warning and monitor/defibrillator shut down. Therefore, when the LOW BATTERY warning occurs, install a fully charged battery pack as soon as possible.

The following figure illustrates the effect of lowered battery capacity on the monitor/ defibrillator operating time remaining after the LOW BATTERY warning.

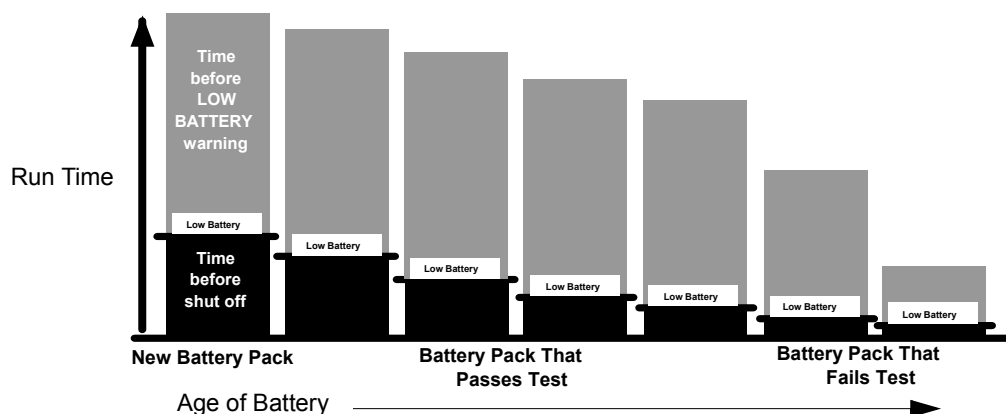

- **DO test battery packs regularly.**

Your organization must determine and implement an appropriate testing schedule. Adherence to this schedule is crucial to identifying battery packs that have reached end of life and should be removed from use. Battery packs subjected to repeated short discharge and charge cycles may lose their capacity quickly. Test the battery packs that you use this way more frequently.

- **DO implement a means of indicating the charge status of battery packs.**

It is important to visibly distinguish battery packs that are charged from those that are not. Establish a system for visually indicating whether a battery pack is charged and ready for use or is in need of charging. ZOLL can provide you with battery pack status labels for this purpose, or you can use labels or methods of your own.

- ***DO exchange your battery packs regularly.***

Battery packs should be exchanged once per shift or once per day depending on their use.

- ***DO carry a fully charged spare battery pack at all times.***

- ∅ ***DON'T remove a partially charged battery pack from the battery charger.***

If a partially charged battery pack is used, a full charge is recommended before its next use. Repeated use after partial charging may quickly diminish the battery's capacity, thereby shortening its life.

- ∅ ***DON'T store battery packs in a fully discharged state.***

Battery pack capacity diminishes if left in a fully discharged state for extended periods.

- ∅ ***DON'T assume that a shift check of the monitor/defibrillator verifies adequate battery pack run time.***

Your Monitor/Defibrillator should be tested daily to verify the readiness of the device. This test, however, does not verify adequate charge state or capacity of the battery pack and may leave the monitor/defibrillator with inadequate run time.

If the device shows a LOW BATTERY warning during testing, replace the depleted battery pack with a fully charged one, and recharge the depleted battery pack.

- ∅ ***DON'T charge battery packs at temperature extremes.***

ZOLL recommends charging battery packs at or near normal room temperature (15°C to 35°C or 59°F to 95°F).

SECTION 13

TROUBLESHOOTING GUIDELINES

The troubleshooting guidelines provided on the following pages are intended for use by non-technical medical personnel during device operation. This section addresses many of the common problems or questions that may arise during operation.

If trouble persists after consulting this guide, contact the appropriate technical personnel or ZOLL Technical Service Department. A more detailed troubleshooting guide is found in the *E Series Service Manual*.

Monitor

Symptom	Recommended Action
Unit does not turn on or unexpectedly shuts off.	<ul style="list-style-type: none"> • Check that battery pack is properly installed. • Verify the unit is plugged into AC power. • Replace battery pack with a fully charged battery pack. • If the internal lithium battery that powers the Real Time Clock is fully depleted, the unit will not power up unless connected to mains power. Qualified service personnel can consult the E Series Service Manual for instructions on replacing the internal battery. You can also contact the ZOLL Technical Service Department for assistance.
Unit displays the <i>X FAULT XX</i> message.	<ul style="list-style-type: none"> • A fault has been detected. • Attempt to clear the <i>X FAULT XX</i> message by turning the selector switch to OFF then back to the desired operating mode. Note: Some settings (e.g. alarm settings, lead selection, ECG size) may need to be restored.
Unit displays the <i>SET CLOCK</i> or <i>CLOCK FAULT</i> prompt.	<ul style="list-style-type: none"> • Set time and date information (see “Setting Time and Date” on page 11-5). • Have qualified service personnel verify that the internal battery has been replaced within the last 5 years, or contact the ZOLL Technical Service Department for assistance. <p>Note: Note: If the internal battery becomes fully depleted, the unit will not power up unless plugged into AC mains.</p>
Unit displays the <i>ECG LEAD OFF</i> or the <i>POOR LEAD CONTACT</i> message.	<ul style="list-style-type: none"> • Ensure that the ECG cable is connected to patient and unit. • Check that ECG electrodes are making good contact and not dried out. • If changing from 5-lead wire ECG patient cable to 3-lead ECG patient cable, make sure to turn the unit OFF for at least 10 seconds. • Replace ECG cable.

Symptom	Recommended Action
Unit displays the <i>TIME SYNCHRONIZATION REQUIRED</i> message on power down.	<ul style="list-style-type: none"> • More than two weeks have elapsed since the clock was last synchronized. Synchronize the clock as described in “Setting Time and Date” on page 11-5.”
Unit displays the <i>CABLE FAULT</i> or <i>PADDLE FAULT</i> message.	<ul style="list-style-type: none"> • Check the connection between the Multifunction cable and the MFE pads. • Remove the CPRD-to-MFC connector, if in use, and plug the multifunction cable directly into the CPR-D-padz. • Remove the multifunction cable PADS from the AutoPulse Plus, if in use, and plug the multifunction cable directly into the electrode pads.
Noisy ECG, artifact, wandering baseline	<ul style="list-style-type: none"> • Consider 1 – 21Hz filter bandwidth (see E Series Configuration Guide). • Prepare the patient’s skin prior to electrode attachment. • Check for proper adhesion of electrodes to patient. • Reduce or eliminate ECG artifact due to electrode or patient cable movement. • Route cables so that they don’t pull on electrodes or swing excessively. • Ensure patient is motionless. • Check for possible excessive radio frequency interference.
Poor ECG signal level observed with normal calibration pulse.	<ul style="list-style-type: none"> • Select another lead. • Apply new electrodes using different placement.
Inconsistent QRS beep or heart rate is observed.	<ul style="list-style-type: none"> • Increase beeper volume. • Select another lead. • Alter ECG electrode placement and/or use new electrode.
Sync marker is absent or inconsistent with QRS waveform on display and stripchart.	<ul style="list-style-type: none"> • Ensure device is in SYNC mode. • Change ECG lead selection. • Alter ECG electrode placement and/or use new electrode. • Ensure paper is at least 90 mm wide.

Recorder

Symptom	Recommended Action
Unit displays the <i>CHECK RECORDER</i> prompt.	<ul style="list-style-type: none"> • Ensure the recorder door is shut properly. • Ensure adequate paper supply in recorder paper tray (see “Changing Recorder Paper” on page 11-4). • Remove paper, check paper type, check recorder for paper jam, and then reload paper.
Recorder makes stuttering sound when activated.	<ul style="list-style-type: none"> • Check recorder for paper jam.
Light or poor quality printing is observed.	<ul style="list-style-type: none"> • Ensure correct paper type (ZOLL P/N 8000-0300) is in use. • Ensure paper is installed grid-side against recorder print head. • Ensure that door is latched shut properly. You must listen for clicks on both corners of the door when latching the door shut. • Clean recorder print head (see “Cleaning the Recorder Printhead” on page 11-1).
Summary report does not print when you press SUMMARY button.	<ul style="list-style-type: none"> • Wait 15 seconds and try again. (The unit requires 15 seconds after an event occurs to finish storing a record of the event. A summary report cannot be printed during this time.)

Pacer (Pacer version only)

Symptom	Recommended Action
Unit displays the <i>CHECK PADS</i> prompt.	<ul style="list-style-type: none"> • Ensure MFE Pads are connected to Multi-Function cable. • Ensure electrode gel is not dry. Replace MFE Pads if necessary. • Ensure good electrode-to-patient contact. • Check integrity of Multi-Function cable by plugging into test connector. <i>CHECK PADS</i> prompt should disappear.
No pacing marker () present on the ECG trace.	<ul style="list-style-type: none"> • Ensure unit is in PACER mode. • Ensure PACER RATE (ppm) is set greater than patient heart rate.
No ventricular capture beat after pacing marker is seen on ECG display.	<ul style="list-style-type: none"> • Check patient's pulse. • Increase output current (mA). • Ensure MFE Pads are making good contact with the patient, or review MFE pad placement. • Select different ECG lead configuration.
Patient receives intermittent pacing stimulus during standby pacing.	<ul style="list-style-type: none"> • Ensure proper ECG electrode connection and placement. If ECG lead wire comes off, pacer automatically paces asynchronously. • Check ECG cable for damage. • Patient R-to-R interval varying. Pace rate close to patient rate. Verify rate is set appropriately.
Heart rate display reads 0 with proper pacing capture displayed on ECG trace.	<ul style="list-style-type: none"> • Check patient's pulse. • Select different ECG Lead configuration.
Bedside/Central Station/Telemetry ECG display becomes erratic when pacing.	<ul style="list-style-type: none"> • Patient monitor ECG inputs overloaded by pacer signals. ECG can only be monitored by the device while pacing.

Defibrillator

Symptom	Recommended Action
Excessive artifact when using paddles as ECG source.	<ul style="list-style-type: none"> • Ensure PADDLES is selected. • Firmly press paddles against patient skin. • Use gel on paddles. • Clean paddle surface. • Check and clean between adult and pediatric shoe. • Check cable for damage. • Use MFE electrodes for ECG analysis.
Defibrillator will not charge (energy level does not increment on display).	<ul style="list-style-type: none"> • Check SHOCK button(s) on paddles or front panel are not stuck on. • Replace battery with a fully charged battery pack.
Charge time to 200 J exceeds 10 seconds.	<ul style="list-style-type: none"> • Typical in a low battery condition (up to 20 seconds) • Change battery pack. • Plug device into AC power. • Install fully charged battery pack.
Energy does not discharge when you press SHOCK button(s).	<ul style="list-style-type: none"> • 60 seconds have elapsed in Manual mode since initial charge ready. Energy was internally discharged. • 15 seconds have elapsed in automatic mode since initial charge ready. Energy was internally discharged. • Device is in SYNC mode and no QRS complex is detected. • Energy internally discharged because energy selection was changed during charge or after the device was ready. • Unit not completely charged when you pressed SHOCK button(s). Wait for <i>DEFIB XXXJ READY</i> message and ready tone. • Press and hold SHOCK button(s) until energy is delivered to the patient. • Device is connected to the AutoPulse Plus and no relaxation period of the compression cycle has been detected yet.
Unit is unable to SHOCK when in SYNC mode.	<ul style="list-style-type: none"> • Ensure <i>SYNC XXXJ SEL</i> message is displayed on monitor. • Check for SYNC marker above R wave. If not present, change ECG size, lead selection, or electrode placement. • Press and hold SHOCK button(s) until energy is delivered to the patient. • Alter ECG electrode placement. • Make sure ECG signals are displayed.

Symptom	Recommended Action
No energy delivery to patient is apparent.	<ul style="list-style-type: none"> • Under certain circumstances, some patients do not twitch when energy is delivered. • Perform defibrillator self test as described in “General Maintenance” on page 11-1. • Check for <i>CHECK PADS</i> and <i>POOR PAD CONTACT</i> messages alternating on the monitor. • If Multi-Function electrodes are used, ensure proper placement and contact.
Unit displays <i>PADDLE FAULT</i> message when connected to the AutoPulse Plus.	<ul style="list-style-type: none"> • Discharge energy internally by changing the energy selection. • Disconnect the Multi-Function Cable and PADS from the AutoPulse Plus, and connect the Multi-Function Cable directly to the PADS.
Unit displays the <i>CHECK PADS</i> prompt.	<ul style="list-style-type: none"> • Verify proper Multi-Function Cable/MFE Pad connection by disconnecting and reconnecting the Multi-Function cable and MFE Pads. • Ensure proper contact of Multi-Function Pads and that the patient does not have excessive hair beneath the electrodes. • If message persists, disconnect Multi-Function cable from MFE Pads and plug cable into test connector. <i>CHECK PADS</i> prompt should change to <i>DEFIB PAD SHORT</i> (Manual mode only). • If test fails, try using paddles to defibrillate.
Unit displays the <i>USE PADS</i> prompt.	<ul style="list-style-type: none"> • The ECG analysis function operates only when MFE pads are attached to the patient. You must either: <ul style="list-style-type: none"> • Disconnect paddle and connect MFE Pads for use in Semiautomatic defibrillation. • Activate Manual mode to use paddles.
Unit displays the <i>NOISY ECG</i> or the <i>RETRY ANALYSIS</i> prompt.	<ul style="list-style-type: none"> • Check for proper application and adhesion of Multi-Function electrodes. • Check to make sure that nobody is touching the patient and that the patient is motionless.
Unit displays the <i>ECG TOO LARGE</i> , or the <i>RETRY ANALYSIS</i> prompt.	<ul style="list-style-type: none"> • Press ANALYZE button again to begin analysis.
No <i>TEST OK</i> message appears when performing a defibrillator self-test.	<ul style="list-style-type: none"> • Check to make sure unit is set to 30 Joules. • If testing with Multi-Function Cable, make sure that cable is firmly inserted into test connector. • If testing with paddles, make sure to press the paddles firmly against the sides of the unit while discharging.
Unit displays the <i>DEFIB MAINT. REQUIRED</i> message.	<ul style="list-style-type: none"> • Contact ZOLL Technical Service Department.
Unit displays a <i>DEFIB FAULT XX</i> message.	<ul style="list-style-type: none"> • If problem persists, contact ZOLL Technical Service Department.

AC Charger

Symptom	Recommended Action
The green and orange-yellow CHARGER ON indicators illuminate alternately.	<ul style="list-style-type: none"> • Verify battery is installed. • Turn unit ON to identify the fault condition. • Replace battery pack with a fully charged battery pack. • If problem persists, replace battery pack, unplug device from AC mains and plug device back into AC mains.
Unit displays the <i>LOW BATTERY</i> message when it is plugged into AC mains.	<ul style="list-style-type: none"> • Replace battery pack with a fully charged battery pack. • Unplug device from AC mains and plug device back into AC mains. • Verify AC mains is working properly.
None of the CHARGER ON indicators are illuminated when the device is plugged into AC mains.	<ul style="list-style-type: none"> • Unplug device from AC mains and plug device back into AC mains. • Verify AC mains is working properly.

(This page intentionally left blank.)

APPENDIX A

SPECIFICATIONS

General

Size	5.75 in. high x 13.1 in. wide x 10.5 in. deep 14.6 cm high x 33.3 cm wide x 26.7 cm deep
Weight	Approximately 13.2 lbs (5.99 kg)
Power	5 cells, 2 V/cell; wired in series (sealed lead acid battery pack) 3 cells, 4.2 V/cell; wired in series (lithium-ion battery pack)
AC Power	100-120V ~ 50/60 Hz, 220-240V ~ 50 Hz, 220 VA
DC Input (Optional)	10-29 V. 130 W
Device Classification	Class I and internally powered per IEC 60601-1. Class II and internally powered per IEC 60601-1 (DC input ONLY).
Design Standards	Meets or exceeds UL 60601-1, AAMI DF-80, IEC 60601-2-4, EN 60601-2-25, and EN 60601-2-27.
Patient Safety	All patient connections are electrically isolated.
Environmental	
Temperature:	Operating: 0° C to 55° C (32° F to 131° F) Storage Temperature: -20° to 60°C (-4° F to 140° F) Note: The E Series device may not perform to specifications when stored at the upper or lower extreme limits of storage temperature and immediately put into use.
Humidity:	5 to 95% relative humidity, non-condensing
Vibration:	Mil-Std-810F, Minimum Integrity Test
Shock:	IEC 68-2-27, 100 g 6 mS half sine
Operating Pressure:	594 to 1060 mBar
Material Ingress:	IP34 per EN 60601-1
Electromagnetic Compatibility (EMC):	CISPR 11 Class B - Radiated and Conducted Emissions CISPR 11 Class A - Radiated and Conducted Emissions (DC input only)
Electromagnetic Immunity	AAMI DF-80, IEC 61000-4-3 to 10 V/m
Electrostatic Discharge	AAMI DF-80, IEC 61000-4-2
Conducted Susceptibility	IEC 61000-4-4, IEC 61000-4-5, IEC 61000-4-6

Pacemaker (Pacer version)

Type	VVI demand; asynchronous (fixed rate) when used without ECG leads or in ASYNC pacing mode
Pulse Type	Rectilinear, constant current
Pulse Shape and Duration	Rectilinear, 40 milliseconds \pm 2 milliseconds
Pulse Amplitude	Variable 0 mA to 140 mA \pm 5% or 5 mA, whichever is greater Digitally displayed on the monitor (increments or decrements by a value of 2 mA)
Pacing Rate	Variable from 30 ppm to 180 ppm \pm 1.5% (increments or decrements by a value of 2 ppm)
Output protection	Fully defibrillator protected and isolated
Multi-Function Electrode (MFE) Pads	Specifically designed adult anterior/posterior pre-gelled ZOLL MFE Pads and Multi-Function stat-padz packaged in pairs

Defibrillator

Waveform	Rectilinear Biphasic
Energy Selection	Adult Mode: Selectable at 1, 2, 3, 4, 5, 6, 7, 8, 9, 10, 15, 20, 30, 50, 70, 85, 100, 120, 150, 200 J (Delivered into 50 Ω load). Selected using controls on sternum paddles or unit front panel.
Charge Time	<ul style="list-style-type: none"> • Less than 6 seconds with a new, fully charged battery (first 15 charges to 200 joules). Depleted batteries result in a longer defibrillator charge time. • Less than 15 seconds when operating without a battery, using AC power alone at 90% of the rated mains voltage. • Less than 15 seconds with a new, fully charged battery pack, depleted by up to 15 200 Joule discharges. • Less than 25 seconds from the initial power on, with a new, fully charged battery pack, depleted by up to 15 200 Joule discharges. • Less than 25 seconds from the initial power on when operating without a battery, using AC power alone at 90% of the rated mains voltage. • Less than 30 seconds from initiation of rhythm analysis (Semiautomatic mode) with a new, fully charged battery pack, depleted by up to 15 200 Joule discharges. • Less than 30 seconds from initiation of rhythm analysis (Semiautomatic mode) when operating without a battery, using AC power alone at 90% or greater of the rated mains voltage. • Less than 40 seconds from initial power on (Semiautomatic mode) with a new, fully charged battery pack, depleted by up to 15 200 Joule discharges. • Less than 40 seconds from initial power on (Semiautomatic mode) when operating without a battery, using AC power alone at 90% or greater of the rated mains voltage.
Patient Impedance Range	Minimum: 15 oms Maximum: 250 ohms
Energy Display	Monitor display indicates both selected and delivered energy.
Synchronized Mode	Synchronizes defibrillator pulse to patient's R-wave. SYNC message displayed on monitor. Marker on display and recorder paper identifies R-wave discharge point. Meets the DF-80:2003 requirement of 60ms maximum time delay between sync pulse and delivery of energy, where the ECG is derived via an applied part, once the output has been activated.
Charge Controls	Control on apex paddle and on device front panel.

Paddles	Standard apex/sternum adult and pediatric. Adult paddles slide off to expose pediatric paddles.
Multi-Function Electrode (MFE) Pads	Specifically designed adult anterior/posterior pregelled ZOLL MFE Pads and Multi-Function stat-padz packaged in pairs.
Built-in Defibrillator Tester	Provides verification of the defibrillator charging and discharging without removing paddles from storage wells or verification of unit configured with Multi-Function Cable.
Multi-Function Electrode Impedance Measurement	Range: 0 ohms - 250 ohms Accuracy: $\pm 10\%$ or 5 ohms, whichever is greater.
Defibrillation Advisory	Evaluates electrode connection and patient ECG to determine if defibrillation is required. Shockable Rhythms: Ventricular fibrillation with amplitude $> 100 \mu\text{V}$ and wide complex ventricular tachycardia with rates greater than 150 bpm. Refer to the ECG Analysis Algorithm Accuracy section for sensitivity and specificity performance.

ECG Monitoring

Patient Connection	3-lead ECG cable, 5-lead wire ECG cable, paddles or MFE Pads. Selectable by front panel switch.
Input Protection	Fully defibrillator-protected. Special circuit prevents distortion of ECG by pacer pulse. (Pacer version only).
Implanted Pacemaker Spike Display	Dedicated circuitry detects most implanted pacemaker spikes and provides standard display marker of spike on ECG trace.
Implanted Pulses Detected	$\pm 2\text{mV}$ to $\pm 700\text{mV}$, 0.1ms to 2ms width, with a recharge constant of 0 to 100ms. Note: The pacemaker pulse rejection capability for the E Series with pacemaker pulses alone includes pulses between $\pm 2\text{mV}$ and $\pm 700\text{mV}$ amplitude, with widths between 0.1ms and 2ms, without overshoot, and between $\pm 100\text{mV}$ and $\pm 500\text{mV}$, with widths between 0.1ms and 2ms, with overshoot from 4 to 100ms. The pacemaker pulse rejection capability for the E Series with pacemaker pulses and a normally paced QRS and T wave includes pulses between $\pm 2\text{mV}$ and $\pm 700\text{mV}$ amplitude, with widths between 0.1ms and 2ms, without overshoot, and between $\pm 2\text{mV}$ and $\pm 500\text{mV}$, with widths between 0.1ms and 2ms, with overshoot from 4 to 100ms. The pacemaker pulse rejection capability for the E Series with pacemaker pulses with an ineffectively paced QRS pattern includes pulses between $\pm 100\text{mV}$ and $\pm 700\text{mV}$ amplitude, with widths between 0.1ms and 2ms, without overshoot, and between $\pm 100\text{mV}$ and $\pm 500\text{mV}$, with widths between 0.1ms and 2ms, with overshoot from 4 to 100ms. The E Series is not capable of rejecting A-V Sequential pacemaker pulses.
Bandwidth	0.67 Hz - 21 Hz (-3 dB) standard/0.05 Hz - 150 Hz Diagnostic 0.67 Hz - 27 Hz and 1 Hz - 21 Hz user-configurable
Lead Selection	Displayed on monitor
ECG Size	0.5, 1, 1.5, 2, 3 cm/mV (Centimeter per millivolt) display on monitor
Heart Rate	Digital display Range: 0 bpm - 300 bpm Accuracy: $\pm 5\%$

Heart Rate Alarm	Screen icon indicates activated/deactivated status. User-selectable. Tachycardia 60 bpm - 280 bpm, bradycardia 20 bpm - 100 bpm
Tall T-wave Rejection	≤ 1.0 mV
Heart Rate Averaging	The E Series averages the interval between the last 5 detected beats. On startup, the E Series averages the rate between detected beats once two beats are detected, until a full 5 beats have been received. The rate is updated every beat. After this condition is met, the meter is updated every beat with an average of the last 5 beats. If a period of time greater than 5 seconds elapses without a beat detected, the heart rate meter reports a rate of 0 bpm, which is repeated every 5 seconds.
Accuracy and Response Time to Irregular Rhythm	Averaging over 5 R-R intervals, per AAMI EC 13:2002: <ul style="list-style-type: none"> Ventricular Bigeminy (Figure 3a) - 40 bpm Slow alternating ventricular bigeminy (Figure 3b) - 60 bpm Rapid alternating ventricular bigeminy (Figure 3c) - 120 bpm Bidirectional systoles (Figure 3d) - 90 bpm
Response Time to Change in Heart Rate	80 to 120 bpm: 4 seconds 80 to 40 bpm: 4 seconds
Time to Alarm for Tachycardia	206 bpm (1 mV): 4.80 seconds 206 bpm (halved amplitude): 9.90 seconds 206 bpm (doubled amplitude): 4.00 seconds 195 bpm (2 mV): 4.20 seconds 195 bpm (halved amplitude): 8.00 seconds 195 bpm (doubled amplitude): 4.00 seconds
Leads Off Sensing	A DC current of 0.04 μ A per lead wire is supplied to the patient.
Active Noise Suppression	The sum of all leadwire currents is returned via the active noise suppression leadwire: <ul style="list-style-type: none"> 0.08 μA DC in 3 lead mode 0.16 μA DC in 5 lead mode 0.36 μA DC in 12 lead mode
1 Volt ECG Out	1.0 Volt/cm (volt per centimeter) of deflection on stripchart recorder < 25 ms delay from patient ECG input Bandwidth ≥ 150 Hz Output impedance = 250 ohms Internal pacemaker pulses represented as on display ECG x 1000 provided at rear connector panel via a standard 3.5 mm mono jack. ECG signal is on tip; ground is on ring
Display Format	Non-fade moving bar display

CPR Monitoring

Compression Depth	0.75 to 3 inches ± 0.25 inches 1.9 to 7.6 cm ± 0.6 cm
Compression Rate	50 to 150 compressions per minute

Display

Screen Type	High resolution, color liquid crystal display (LCD)
Screen Size	5.63 inches (14.3 cm) diagonally
Sweep Speed	25 mm/s
Viewing Time	4 seconds
Messages	ERASING REPORT, INSERT CARD, CARD FULL, REPLACE BATTERY, LOW BATTERY, PERFORM CPR, ECG TOO LARGE, NOISY ECG, RETRY ANALYSIS, CHECK PATIENT, ANALYSIS HALTED, PRESS ANALYZE, NO SHOCK ADV., CHECK PULSE, SHOCK ADVISED, PRESS CHARGE, SELECT PADS, SELECT ECG LEADS, SELECT DEFIB MODE, VF ALARMS OFF, DISABLE SYNC, ANALYSIS RESTARTED, CHECK PADS, POOR PAD CONTACT, DEFIB PAD SHORT, PADDLE FAULT, ECG LEAD OFF, USE PADDLE DISCHG, OPEN AIR DISCHARGE, CANNOT CHARGE, RELEASE SHOCK, PRESS SHOCK, TEST OK, TEST FAILED, PACER DISABLED, DEFIB DISABLED, SET PACE MA, SET PACE RATE, CHECK RECORDER, ANALYZING ECG, FULLY RELEASE.

Recorder

Paper	80 mm thermal (grid width) 90 mm (paper width)
Speed	25 mm/s or 50 mm/s (apparent), configurable for 12 lead output
Delay	6 seconds
Annotations	Time, date, defib energy, heart rate, pacemaker output (Pacemaker version only), QRS sync marker, ECG SIZE, lead, alarm, DEFIB TEST OK/FAIL, ANALYZE ECG, PADS OFF, ANALYSIS HALTED, NOISY ECG, SHOCK ADVISED, NO SHOCK ADVISED, ECG TOO LARGE, and diagnostic bandwidth.
Printing Method	High resolution, thermal array print head
Print out Modes	Manual or automatic; user-configurable
On/Off Control	Front panel and paddle
Automatic Function	15 second recording initiated by alarm activation or defibrillator discharge

PCMCIA Card

Capacity	Standard Series II Flash card - 8, 16, or 32 Mb
Audio Recording	Digital compressed audio data

Battery Packs

Type	Rechargeable, sealed lead acid	Lithium ion
Weight	1 kg (2.2 lbs)	0.68 kg (1.5 lbs)
Voltage	2 Volts per cell; 5 cells wired in series	4.2 Volts per cell; 3 cells wired in series
Recharge Time (to 90% capacity)	4 hours or less with integral charger	7 hours or less with integral charger

Operating Time	<p>For a new, fully charged battery pack at 20 °C: (68° F)</p> <ul style="list-style-type: none"> • 40 defibrillator discharges at maximum energy (200 J), or • 2.75 hours of continuous ECG monitoring, or • 2.25 hours of continuous ECG monitoring/pacing at 60 mA, 80 beats per minute. 	<p>For a new, fully charged battery pack at 20 °C: (68° F)</p> <ul style="list-style-type: none"> • 100 defibrillator discharges at maximum energy (200 J), or • 4.25 hours of continuous ECG monitoring, or • 3.75 hours of continuous ECG monitoring/pacing at 60 mA, 80 beats per minute. <p>Standby Life: one month before retest and recharge.</p>
	<p>Note: Each monitoring option added to the E Series device decreases the Operating Time that can be obtained from a fully charged battery. Refer to the individual option insert for the operating run time specific to your device. For further details specific to your device, contact the ZOLL Technical Service Department.</p>	
Low Battery Indicators	<p>Message is displayed on the monitor and a 2-beep, low battery tone sounds once a minute until just before shutdown, when it beeps twice every 2 seconds. The time from display of the <i>LOW BATTERY</i> or <i>REPLACE BATTERY</i> prompt until the instrument shuts down varies depending upon the battery age and condition.</p>	

Guidance and Manufacturer's Declaration – Electromagnetic Emissions

The E Series unit is intended for use in the electromagnetic environment specified below. Ensure that the E Series unit is used in such an environment.

Emissions Test	Compliance	Electromagnetic Environment — Guidance
RF emissions CISPR11	Group 1	The E Series unit uses RF energy only for its internal function. Therefore, its RF emissions are very low and are not likely to cause any interference in nearby electronic equipment.
RF emissions CISPR 11	Class B Class A	The E Series unit is suitable for use in all establishments, including domestic establishments and those directly connected to the public low-voltage power supply network that supplies buildings used for domestic purposes. Class A equipment is equipment suitable for use in all establishments other than domestic and those directly connected to a low voltage power supply network which supplies buildings used for domestic purposes.
Harmonic Emission IEC 61000-3-2	Class A	
Voltage Fluctuations/ Flicker Emission IEC 61000-3-3	Complies	
Medical Electrical Equipment needs special precautions regarding EMC and needs to be installed and put into service according to EMC information provided in this document.		

Electromagnetic Immunity Declaration (EID)

Immunity Test	IEC 60601 Test Level	Compliance Level	Electromagnetic Environment — Guidance
Electrostatic discharge (ESD) IEC 61000-4-2	± 6 kV contact ± 8 kV air	± 6 kV contact ± 8 kV air	Floors should be wood, concrete or ceramic tile. If floors are covered with synthetic material, the relative humidity should be at least 30%.
Electrical fast transient/burst IEC 61000-4-4	± 2 kV for power supply lines ± 1 kV for input/output lines	± 2 kV for power supply lines Not applicable	Mains power quality should be that of a typical commercial or hospital environment.
Surge IEC 61000-4-5	± 1 kV differential mode ± 2 kV for common mode	± 1 kV differential mode ± 2 kV for common mode	Mains power quality should be that of a typical commercial or hospital environment.
Voltage dips, short interruptions and voltage variations on power supply input lines IEC 61000-4-11	<5% U_T (>95% dip in U_T) for 0.5 cycle 40% U_T (60% dip in U_T) for 5 cycles 70% U_T (30% dip in U_T) for 25 cycles <5% U_T (>95% dip in U_T) for 5 sec.	<5% U_T (>95% dip in U_T) for 0.5 cycle 40% U_T (60% dip in U_T) for 5 cycles 70% U_T (30% dip in U_T) for 25 cycles <5% U_T (>95% dip in U_T) for 5 sec.	Mains power quality should be that of a typical commercial or hospital environment. If the user of the E Series unit requires continued operation during power mains interruptions, it is recommended that the E Series unit be powered by an uninterruptible power supply or a battery.
Power frequency (50/60 Hz) magnetic field IEC 61000-4-8	3 A/m	3 A/m	Power frequency magnetic fields should be at levels characteristic of a typical location in a typical commercial or hospital environment.
Note: U_T is the AC mains voltage prior to application of the test level.			

EID for Life-Support Functions

The life-support functions^a of the E Series unit are intended for use in the electromagnetic environment specified below. Ensure that the E Series unit is used in such an environment.

Immunity Test	IEC 60601 Test Level	Compliance Level	Electromagnetic Environment — Guidance
<p>Conducted RF IEC 61000-4-6</p> <p>Radiated RF IEC 61000-4-3</p>	<p>3 Vrms 150 kHz to 80 MHz outside ISM bands^b</p> <p>10 Vrms 150 kHz to 80 MHz in ISM bands^b</p> <p>10 V/m 80 MHz to 2.5 GHz</p>	<p>3 Vrms</p> <p>10 Vrms</p> <p>10 V/m</p>	<p>Portable and mobile RF communications equipment should be used no closer to any part of the E Series unit, including cables, than the recommended separation distance calculated from the equation applicable to the frequency of the transmitter.</p> <p>Recommended Separation Distance</p> <p>$d = 1.2 \sqrt{P}$</p> <p>$d = 1.2 \sqrt{P}$</p> <p>$d = 1.2 \sqrt{P}$ 80 MHz to 800 MHz $d = 2.3 \sqrt{P}$ 800 MHz to 2.5 GHz</p> <p>where P is the maximum output power rating of the transmitter in watts (W) according to the transmitter manufacturer, and d is the recommended separation distance in meters (m).^c</p> <p>Field strengths from fixed RF transmitters, as determined by an electromagnetic site survey,^d should be less than the compliance level in each frequency range.^e</p> <p>Interference may occur in the vicinity of equipment marked with the following symbol: </p>
<p>NOTE 1 At 80 MHz, the higher frequency range applies.</p>			
<p>NOTE 2 These guidelines may not apply in all situations. Electromagnetic propagation is affected by absorption and reflection from structures, objects and people.</p>			
<p>^a The life-support functions on the E Series unit are pacing and defibrillation.</p>			
<p>^b The ISM (industrial, scientific, and medical) bands between 150 kHz and 80 MHz are 6.765 MHz to 6.795 MHz; 13.553 MHz to 13.567 MHz; 26.957 MHz to 27.283 MHz; and 40.66 MHz to 40.70 MHz.</p>			
<p>^c The compliance levels in the ISM frequency bands between 150 kHz and 80 MHz and in the frequency range 80 MHz to 2.5 GHz are intended to decrease the likelihood that mobile/portable communications equipment could cause interference if it is inadvertently brought into patient areas. For this reason, an additional factor of 10/3 is used in calculating the recommended separation distance for transmitters in these frequency ranges.</p>			
<p>^d Field strengths from fixed transmitters, such as base stations for radio (cellular/cordless) telephones and land mobile radios, amateur radio, AM and FM radio broadcast and TV broadcast cannot be predicted theoretically with accuracy. To assess the electromagnetic environment due to fixed RF transmitters, an electromagnetic site survey should be considered. If the measured field strength in the location in which the E Series unit is used exceeds the applicable RF compliance level above, the E Series unit should be observed to verify normal operation. If abnormal performance is observed, additional measures may be necessary, such as reorienting or relocating the E Series unit.</p>			
<p>^e Over the frequency range 150 kHz to 80 MHz, field strengths should be less than 10 V/m.</p>			

Recommended Separation Distances from RF Equipment for E Series Life-Support Functions

The life-support functions^a of the E Series unit is intended for use in an environment in which radiated RF disturbances are controlled. You can help prevent electromagnetic interference by maintaining a minimum distance between portable and mobile RF communications equipment (transmitters) and the E Series unit as recommended below, according to the maximum output power of the communications equipment.

Rated Maximum Output Power of Transmitter (W)	Separation Distance According to Frequency of Transmitter (m)			
	150 kHz to 80 MHz outside ISM bands $d = 1.2 \sqrt{P}$	150 kHz to 80 MHz in ISM bands $d = 1.2 \sqrt{P}$	80 MHz to 800 MHz $d = 1.2 \sqrt{P}$	800 MHz to 2.5 GHz $d = 2.3 \sqrt{P}$
0.01	0.12	0.12	0.12	0.23
0.1	0.38	0.38	0.38	0.73
1	1.2	1.2	1.2	2.3
10	3.79	3.79	3.8	7.3
100	12	12	12	23

For transmitters rated at a maximum output power not listed above, the recommended separation distance d in meters (m) can be determined using the equation applicable to the frequency of the transmitter, where P is the maximum output power rating of the transmitter in watts (W) according to the transmitter manufacturer.

NOTE 1 At 80 MHz and 800 MHz, the separation distance for the higher frequency range applies.

NOTE 2 The ISM (industrial, scientific and medical) bands between 150 kHz and 80 MHz are 6.765 MHz to 6.795 MHz; 13.553 MHz to 13.567 MHz; 26.957 MHz to 27.283 MHz; and 40.66 MHz to 40.70 MHz.

NOTE 3 An additional factor of 10/3 is used in calculating the recommended separation distance for transmitters in the ISM frequency bands between 150 kHz and 80 MHz and in the frequency range 80 MHz to 2.5 GHz to decrease the likelihood that mobile/portable communications equipment could cause interference if it is inadvertently brought into patient areas.

NOTE 4 These guidelines may not apply in all situations. Electromagnetic propagation is affected by absorption and reflection from structures, objects and people.

^a The life-support functions on the E Series unit are defined to be any function associated with Pacing and Defibrillation. Specifically, these functions include, but are not limited to, the pacing pulse output and defibrillation energy discharge.

EID for Non-Life-Support Functions

The non-life-support functions^a of the E Series unit are intended for use in the electromagnetic environment specified below. Ensure that the unit is used in such an environment.

Immunity Test	IEC 60601 Test Level	Compliance Level	Electromagnetic Environment — Guidance
<p>Conducted RF IEC 61000-4-6</p> <p>Radiated RF IEC 61000-4-3</p>	<p>3 Vrms 150 kHz to 80 MHz</p> <p>3 V/m 80 MHz to 2.5 GHz</p>	<p>3 Vrms</p> <p>10 V/m</p>	<p>Portable and mobile RF communications equipment should be used no closer to any part of the E Series unit, including cables, than the recommended separation distance calculated from the equation applicable to the frequency of the transmitter.</p> <p>Recommended Separation Distance</p> <p>$d = 1.2 \sqrt{P}$</p> <p>$d = 0.35 \sqrt{P}$ 80 MHz to 800 MHz</p> <p>$d = 0.7 \sqrt{P}$ 800 MHz to 2.5 GHz</p> <p>where P is the maximum output power rating of the transmitter in watts (W) according to the transmitter manufacturer, and d is the recommended separation distance in meters (m).</p> <p>Field strengths from fixed RF transmitters, as determined by an electromagnetic site survey,^b should be less than the compliance level in each frequency range.^c</p> <p>Interference may occur in the vicinity of equipment marked with the following symbol: </p>
<p>NOTE 1 At 80 MHz, the higher frequency range applies.</p> <p>NOTE 2 These guidelines may not apply in all situations. Electromagnetic propagation is affected by absorption and reflection from structures, objects and people.</p>			
<p>^a The non-life-support functions on the E Series unit are defined to be any function not listed as a life-support function in the “EID for Life Support Functions” table (Note a).</p> <p>^b Field strengths from fixed transmitters, such as base stations for radio (cellular/cordless) telephones and land mobile radios, amateur radio, AM and FM radio broadcast and TV broadcast cannot be predicted theoretically with accuracy. To assess the electromagnetic environment due to fixed RF transmitters, an electromagnetic site survey should be considered. If the measured field strength in the location in which the E Series unit is used exceeds the applicable RF compliance level above, the E Series unit should be observed to verify normal operation. If abnormal performance is observed, additional measures may be necessary, such as reorienting or relocating the E Series unit.</p> <p>^c Over the frequency range 150 kHz to 80 MHz, field strengths should be less than 3 V/m.</p>			

Recommended Separation Distances from RF Equipment for E Series Non-Life-Support Functions

The non-life-support functions^a of the E Series unit is intended for use in an environment in which radiated RF disturbances are controlled. You can help prevent electromagnetic interference by maintaining a minimum distance between portable and mobile RF communications equipment (transmitters) and the E Series unit as recommended below, according to the maximum output power of the communications equipment.

Rated Maximum Output Power of Transmitter (W)	Separation Distance According to Frequency of Transmitter (m)		
	150 kHz to 80 MHz $d = 1.2 \sqrt{P}$	80 MHz to 800 MHz $d = 0.35 \sqrt{P}$	800 MHz to 2.5 GHz $d = 0.7 \sqrt{P}$
0.01	0.12	0.035	0.07
0.1	0.38	0.111	0.22
1	1.2	0.35	0.7
10	3.8	1.11	2.2
100	12	3.5	7.0

For transmitters rated at a maximum output power not listed above, the recommended separation distance d in meters (m) can be determined using the equation applicable to the frequency of the transmitter, where P is the maximum output power rating of the transmitter in watts (W) according to the transmitter manufacturer.

NOTE 1 At 80 MHz and 800 MHz, the separation distance for the higher frequency range applies.

NOTE 2 These guidelines may not apply in all situations. Electromagnetic propagation is affected by absorption and reflection from structures, objects and people.

^a The non-life-support functions on the E Series unit are defined to be any function not listed as a life-support function in the "EID for Life Support Functions" table (Note a). Specifically, these functions are noninvasive blood pressure (NIBP), end-tidal CO₂ (EtCO₂), and SpO₂.

Rectilinear Biphasic Waveform Characteristics

The following table shows the Rectilinear Biphasic™ waveform's characteristics when discharged into 25 ohm, 50 ohm, 100 ohm, and 125 ohm loads at a maximum energy setting of 200 Joules.

	Discharged into 25Ω Load	Discharged into 50Ω Load	Discharged into 100Ω Load	Discharged into 125Ω Load
I_{MAX01} =First Phase Maximum Initial Current	31A	27A	22A	18A
I_{AVG01} =First Phase Average Current	27A	24A	17A	15A
TD 01 =First Phase Duration	6 ms	6 ms	6 ms	6 ms
T_{INTD} = Interphase duration between first and second phases.	150 μs	150 μs	150 μs	150 μs
I_{MAX02} = Second Phase Maximum Initial Current	32A	19A	13A	12A
I_{AVG02} =Second Phase Average Current	17A	14A	11A	10A
TD 02 =Second Phase Duration	4 ms	4 ms	4 ms	4 ms

The efficacy of ZOLL's Rectilinear Biphasic waveform has been clinically verified during a ventricular fibrillation (VF) and ventricular tachycardia (VT) defibrillation study. This study (which was conducted using ZOLL M Series defibrillators) and the findings are described below. Since the E Series unit's rectilinear biphasic waveform employs the same first and second phase timing, the same first and second phase currents/voltages and essentially the same mechanisms for controlling defibrillation waveshape, the ZOLL M Series and ZOLL E Series defibrillation waveforms are considered equivalent.

Table A-1. Delivered Energy at Every Defibrillator Settings into a Range of Loads

Selected Energy	Load							Accuracy
	25 Ω	50 Ω	75 Ω	100 Ω	125 Ω	150 Ω	175 Ω	
1 J	1 J	1 J	1 J	1 J	1 J	1 J	1 J	$\pm 3J$
2 J	1 J	2 J	3 J	2 J	2 J	2 J	2 J	$\pm 3J$
3 J	2 J	3 J	4 J	4 J	3 J	3 J	3 J	$\pm 3J$
4 J	3 J	4 J	5 J	5 J	5 J	4 J	4 J	$\pm 3J$
5 J	4 J	5 J	6 J	6 J	6 J	5 J	5 J	$\pm 3J$
6 J	4 J	6 J	8 J	7 J	7 J	6 J	6 J	$\pm 3J$
7 J	5 J	7 J	9 J	9 J	8 J	8 J	7 J	$\pm 3J$
8 J	6 J	8 J	10 J	10 J	9 J	9 J	8 J	$\pm 3J$
9 J	7 J	9 J	11 J	11 J	10 J	10 J	9 J	$\pm 3J$
10 J	7 J	10 J	13 J	12 J	12 J	11 J	10 J	$\pm 3J$
15 J	11 J	15 J	19 J	19 J	17 J	16 J	15 J	$\pm 3J$
20 J	15 J	19 J	25 J	25 J	23 J	22 J	20 J	$\pm 3J$
30 J	22 J	29 J	38 J	37 J	35 J	32 J	30 J	$\pm 15\%$
50 J	37 J	48 J	63 J	62 J	58 J	54 J	50 J	$\pm 15\%$
70 J	53 J	69 J	90 J	89 J	83 J	77 J	71 J	$\pm 15\%$
85 J	65 J	86 J	112 J	110 J	103 J	96 J	89 J	$\pm 15\%$
100 J	74 J	97 J	126 J	125 J	116 J	108 J	100 J	$\pm 15\%$
120 J	88 J	116 J	151 J	149 J	139 J	129 J	120 J	$\pm 15\%$
150 J	110 J	145 J	188 J	186 J	174 J	161 J	150 J	$\pm 15\%$
200 J	146 J	214 J	238 J	234 J	213 J	195 J	179 J	$\pm 15\%$

Figures A-1 through A-20 show the rectilinear biphasic waveforms that are produced when the E Series defibrillator is discharged into loads of 25, 50, 75, 100, 125, 150, and 175 ohms at each energy setting (200, 150, 120, 100, 85, 70, 50, 30, 20, 15, 10, 9, 8, 7, 6, 5, 4, 3, 2 and 1 joule[s]).

The vertical axis shows the current in amperes (A); the horizontal axis shows the duration in milliseconds (ms).

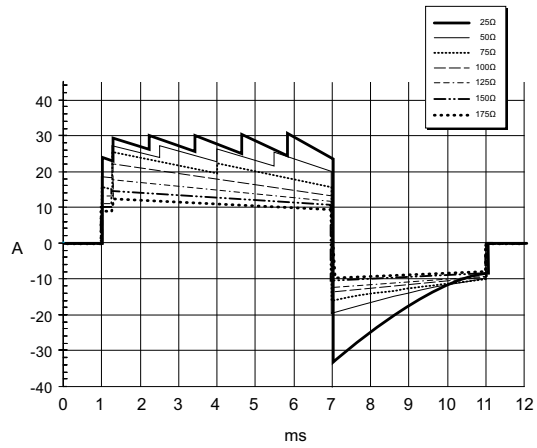

Figure A-1. Rectilinear Biphasic Waveforms at 200 Joules

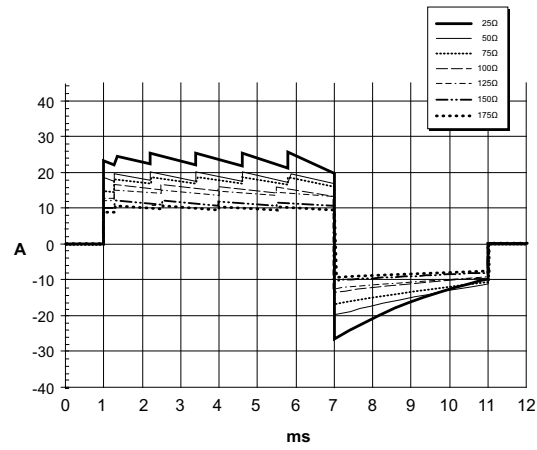

Figure A-2. Rectilinear Biphasic Waveforms at 150 Joules

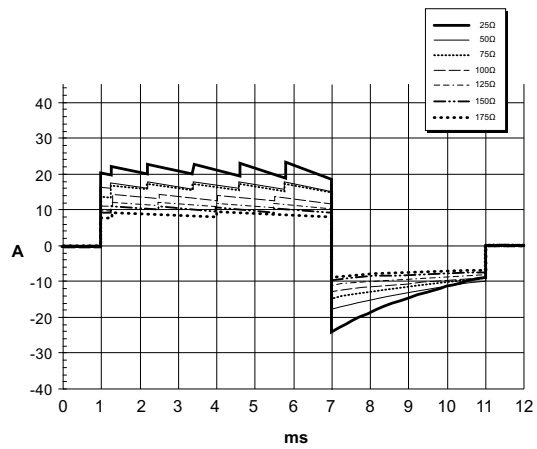

Figure A-3. Rectilinear Biphasic Waveforms at 120 Joules

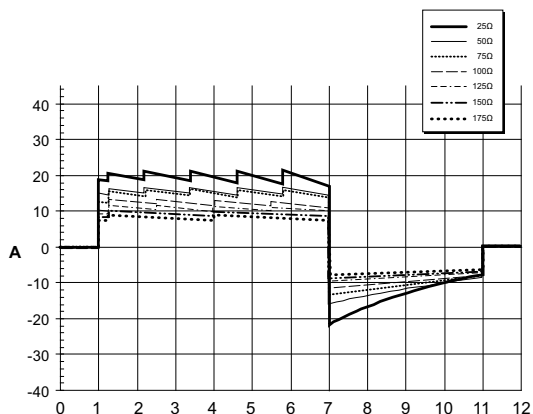

Figure A-4. Rectilinear Biphasic Waveforms at 100 Joules

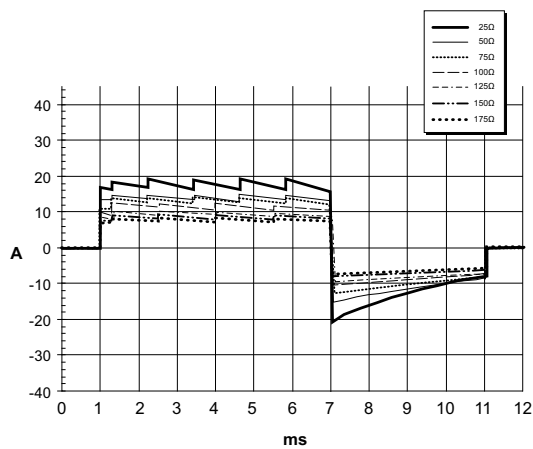

Figure A-5. Rectilinear Biphasic Waveforms at 85 Joules

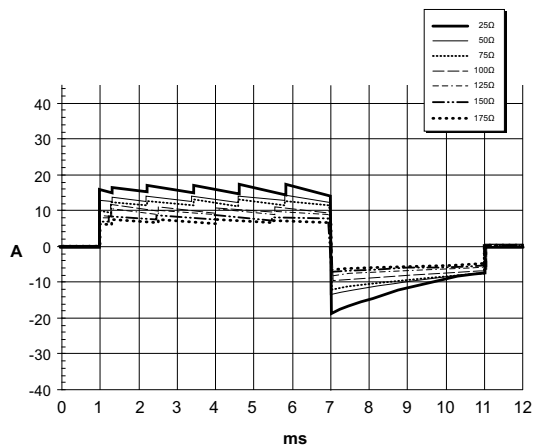

Figure A-6. Rectilinear Biphasic Waveforms at 70 Joules

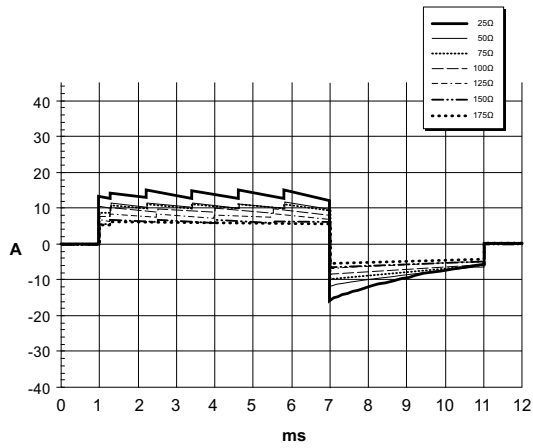

Figure A-7. Rectilinear Biphasic Waveforms at 50 Joules

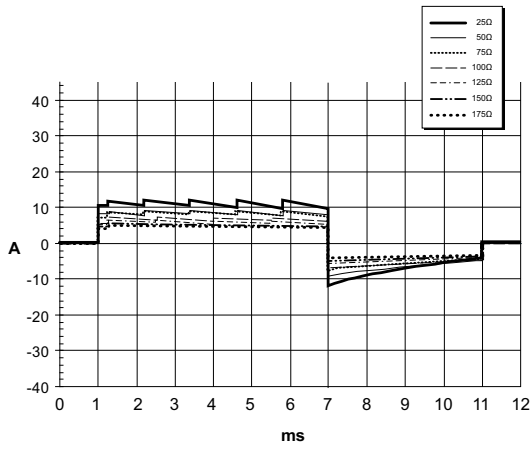

Figure A-8. Rectilinear Biphasic Waveforms at 30 Joules

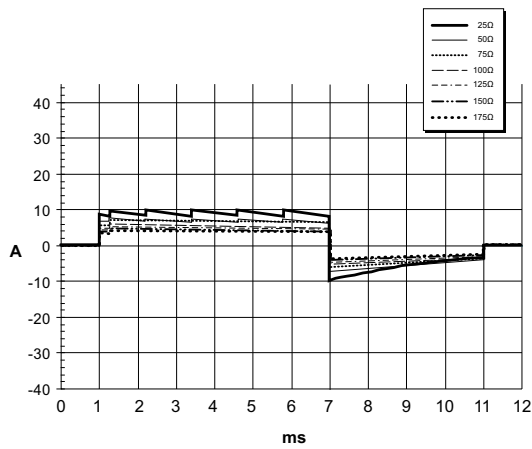

Figure A-9. Rectilinear Biphasic Waveforms at 20 Joules

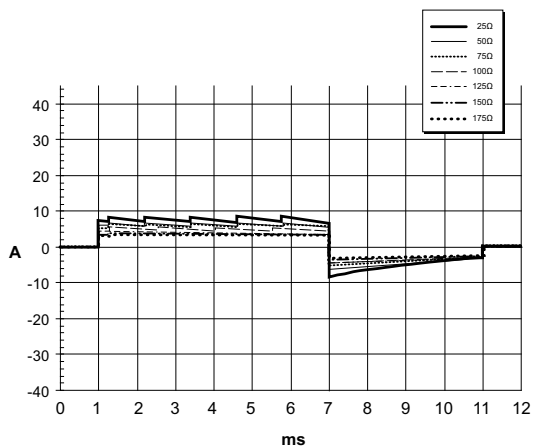

Figure A-10. Rectilinear Biphasic Waveforms at 15 Joules

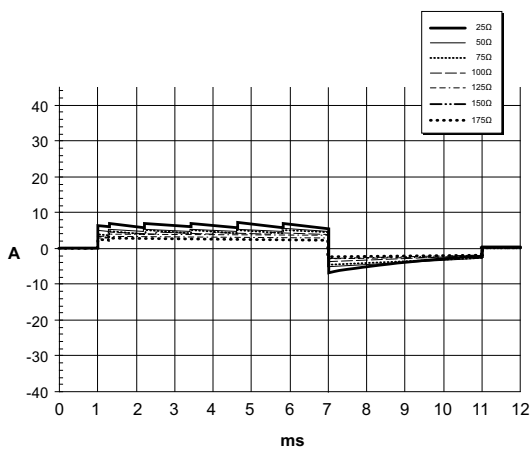

Figure A-11. Rectilinear Biphasic Waveforms at 10 Joules

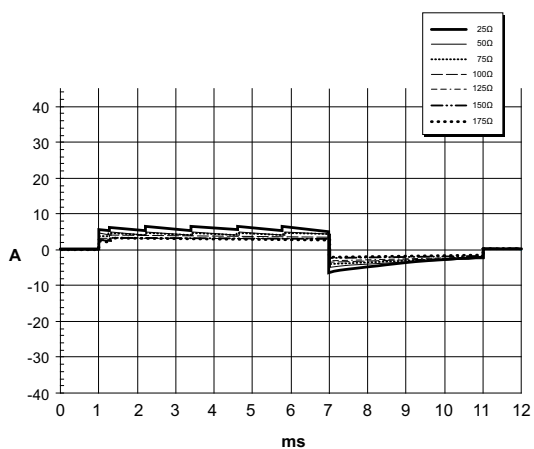

Figure A-12. Rectilinear Biphasic Waveforms at 9 Joules

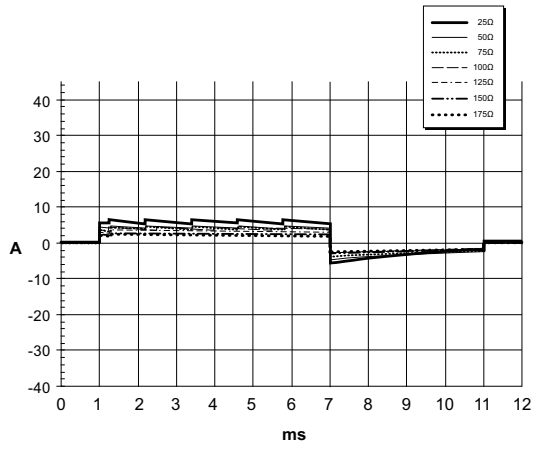

Figure A-13. Rectilinear Biphasic Waveforms at 8 Joules

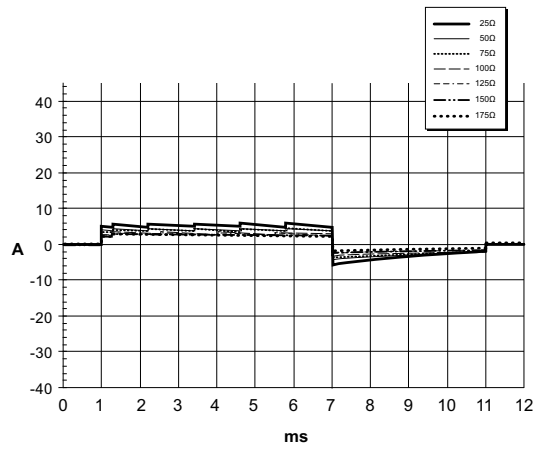

Figure A-14. Rectilinear Biphasic Waveforms at 7 Joules

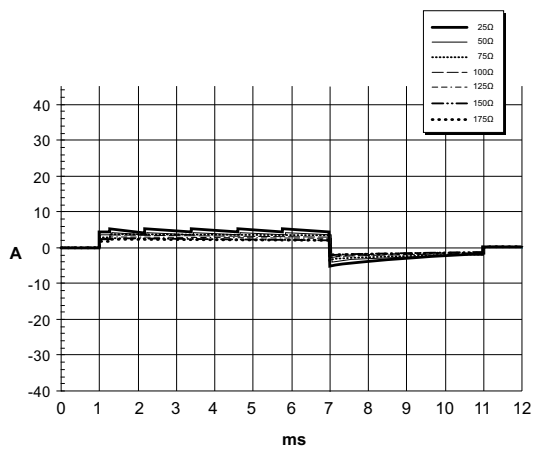

Figure A-15. Rectilinear Biphasic Waveforms at 6 Joules

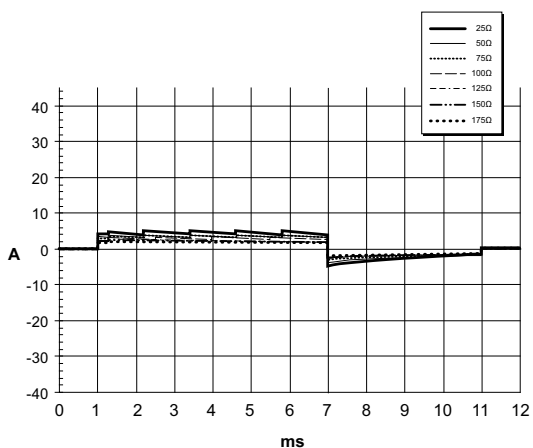

Figure A-16. Rectilinear Biphasic Waveforms at 5 Joules

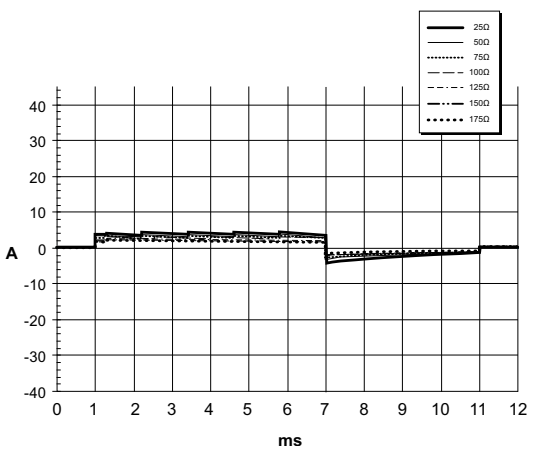

Figure A-17. Rectilinear Biphasic Waveforms at 4 Joules

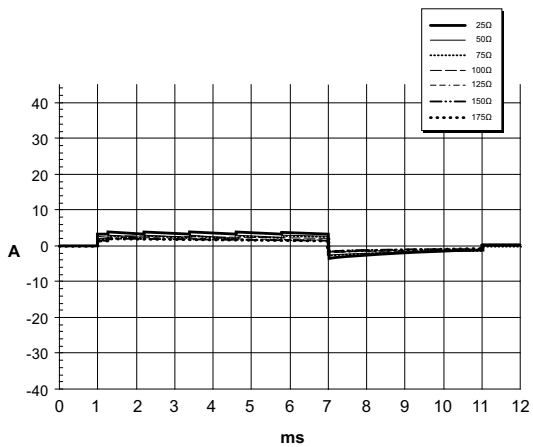

Figure A-18. Rectilinear Biphasic Waveforms at 3 Joules

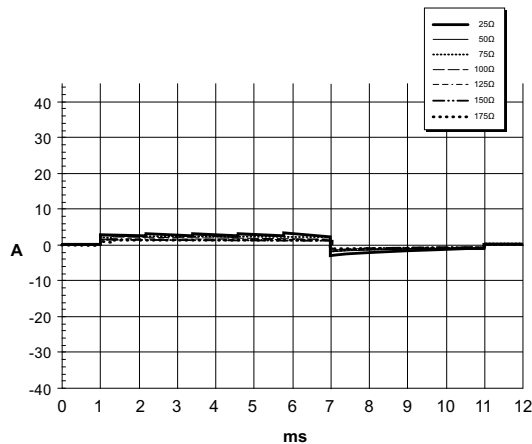

Figure A-19. Rectilinear Biphasic Waveforms at 2 Joules

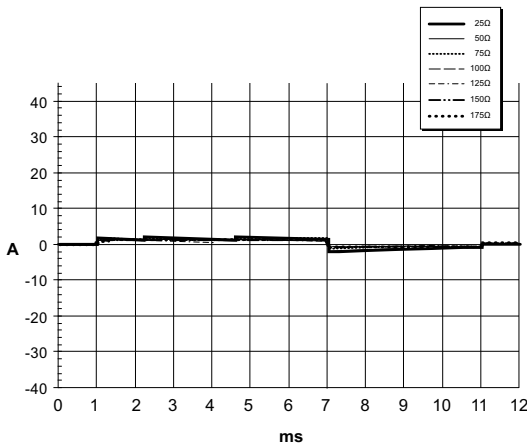

Figure A-20. Rectilinear Biphasic Waveforms at 1 Joules

Clinical Trial Results for the Biphasic Waveform

The efficacy of ZOLL's Rectilinear Biphasic waveform has been clinically verified during a study of defibrillation of Ventricular Fibrillation (VF)/Ventricular Tachycardia (VT). A feasibility study was performed initially for defibrillation of VF/VT (n=20) on two separate groups of patients to ensure waveform safety and energy selection. Subsequently, a separate, multi-center, randomized clinical trial was performed to verify the waveform's efficacy. A description of this study is provided below. The study was performed using ZOLL defibrillation systems consisting of ZOLL defibrillators, the ZOLL Rectilinear Biphasic Waveform and ZOLL Multi-Function pads.

Randomized Multi-Center Clinical Trial for Defibrillation of Ventricular Fibrillation (VF) and Ventricular Tachycardia (VT)

Overview: The defibrillation efficacy of ZOLL's Rectilinear Biphasic waveform was compared to a monophasic damped sine waveform in a prospective, randomized, multi-center study of patients undergoing ventricular defibrillation for VF/VT during electro-physiological studies, ICD implants and tests. A total of 194 patients were enrolled in the study. Ten (10) patients who did not satisfy all protocol criteria were excluded from the analysis.

Objectives: The primary goal of this study was to compare the first shock efficacy of the 120 J rectilinear biphasic waveform with a 200 J monophasic waveform. The secondary goal was to compare all shock (three consecutive 120, 150, 170 J) efficacy of the rectilinear biphasic waveform with that of a monophasic waveform (three consecutive 200,

300, 360 J). A significance level of $p=0.05$ or less was considered statistically significant using Fischer's Exact test. Also, differences between the two waveforms were considered statistically significant when the customary 95% or AHA recommended 90%* confidence interval between the two waveforms was greater than 0%.

Results: The study population of 184 patients had a mean age of 63 ± 14 years. 143 patients were males. 98 patients were in the biphasic group (ventricular fibrillation/flutter, $n=80$; ventricular tachycardia, $n=18$) and 86 patients were in the monophasic group (ventricular fibrillation/flutter, $n=76$; ventricular tachycardia, $n=10$). There were no adverse events or injuries related to the study.

The first shock, first induction efficacy of biphasic shocks at 120 J was 99% versus 93% for monophasic shocks at 200 J ($p=0.0517$, 95% confidence interval of the difference of -2.7% to 16.5% and 90% confidence interval of the difference of -1.01% to 15.3%).

	Monophasic	Biphasic
1st Shock Efficacy	93%	99%
p-value	0.0517	
95% Confidence Interval	-2.7% to 16.5%	
90% Confidence Interval	-1.01% to 15.3%	

Successful defibrillation with rectilinear biphasic shocks was achieved with 58% less delivered current than with monophasic shocks (14 ± 1 vs. 33 ± 7 A, $p=0.0001$).

The difference in efficacy between the rectilinear biphasic and the monophasic shocks was greater in patients with high transthoracic impedance (greater than 90 ohms). The first shock, first induction efficacy of biphasic shocks was 100% versus 63% for monophasic shocks for patients with high impedance ($p=0.02$, 95% confidence interval of the difference of -0.021% to 0.759% and 90% confidence interval of the difference of 0.037% to 0.706%).

	Monophasic	Biphasic
1st Shock Efficacy (high impedance patients)	63%	100%
p-value	0.02	
95% Confidence Interval	-0.021% to 0.759%	
90% Confidence Interval	0.037% to 0.706%	

A single patient required a second biphasic shock at 150 J to achieve 100% defibrillation efficacy versus six patients for whom shocks of up to 360 J were required for 100% total defibrillation efficacy.

Conclusion: The data demonstrate the equivalent efficacy of low energy rectilinear biphasic shocks compared to standard high energy monophasic shocks for transthoracic defibrillation for all patients at the 95% confidence level. The data also demonstrate the superior efficacy of low energy rectilinear biphasic shocks compared to standard high energy monophasic shocks in patients with high transthoracic impedance at the 90% confidence level. There were no unsafe outcomes or adverse events due to the use of the rectilinear biphasic waveform.

Randomized Multi-Center Clinical Trial for Cardioversion of Atrial Fibrillation (AF)

Overview: The defibrillation efficacy of ZOLL's Rectilinear Biphasic waveform was compared to a monophasic damped sine waveform in a prospective randomized multi-center study of patients undergoing cardioversion of their atrial fibrillation. A total of 173 patients entered the study. Seven (7) patients who did not satisfy all protocol criteria were excluded from the analysis. ZOLL disposable gel electrodes with surface areas of 78 cm² (anterior) and 113 cm² (posterior) were used exclusively for the study.

Objective: The primary goal of the study was to compare the total efficacy of four consecutive rectilinear biphasic shocks (70 J, 120 J, 150 J, 170 J) with four consecutive monophasic shocks (100 J, 200 J, 300 J, 360 J). The significance of the multiple shocks efficacy was tested statistically via two procedures, the Mantel-Haenszel statistic and the log-rank test, significance level of $p=0.05$ or less was considered statistically significant. The data are completely analogous to the comparison of two survival curves using a life-table approach where shock number plays the role of time.

The secondary goal was to compare the first shock success of rectilinear biphasic and monophasic waveforms. A significance level of $p=0.05$ or less was considered statistically significant using Fisher Exact tests. Also, differences

between the two waveforms were considered statistically significant when the 95% confidence interval between the two waveforms was greater than 0%.

Results: The study population of 165 patients had a mean age of 66±12 years with 116 male patients.

The total efficacy of consecutive rectilinear biphasic shocks was significantly greater than that of monophasic shocks. The following table displays the Kaplan-Meier (product-limit) survival curves for each of the two waveforms. As all patients begin in the failure mode, the estimated life-table probabilities refer to the chance of still being in failure after the *k*th shock (*k*=1,2,3,4):

Shock #	Kaplan-Meier Estimate for the Probability of Shock Failure	
	Biphasic	Monophasic
0	1.000	1.000
1	0.318	0.792
2	0.147	0.558
3	0.091	0.324
4	0.057	0.208

As can be seen from the table, the biphasic experience is superior over the entire course of shocks delivered. The one degree of freedom chi-square statistic for the Mantel-Haenszel test is 30.39 ($p < 0.0001$). Similarly, the log-rank test, also a one degree of freedom chi-square statistic, is 30.38 ($p < 0.0001$). The residual number of patients not successfully treated after four shocks is 5.7% for biphasic compared to 20.8% for monophasic.

There was a significant difference between the first shock efficacy of biphasic shocks at 70 J of 68% and that of monophasic shocks at 100 J of 21% ($p = 0.0001$, 95% confidence interval of the difference of 34.1% to 60.7%).

Successful cardioversion with rectilinear biphasic shocks was achieved with 48% less delivered current than with monophasic shocks (11 ± 1 vs. 21 ± 4 A, $p < 0.0001$).

One half of the patients who failed cardioversion after four consecutive escalating monophasic shocks were subsequently successfully cardioverted using a biphasic shock at 170 J. No patient was successfully cardioverted using a 360 J monophasic shock after the patient had failed cardioversion with biphasic shocks.

Conclusion: The data demonstrate the superior efficacy of low energy rectilinear biphasic shocks compared to high energy monophasic shocks for transthoracic cardioversion of atrial fibrillation. There were no unsafe outcomes or adverse events due to the use of Rectilinear Biphasic Waveform.

Synchronized Cardioversion of Atrial Fibrillation

Cardioversion of atrial fibrillation (AF) and overall clinical effectiveness is enhanced by proper pad placement. Clinical studies (refer to above) of the M Series Biphasic Defibrillator Waveform demonstrated that high conversion rates are achieved when defibrillation pads are placed as shown in the diagram below.

Recommended Anterior/Posterior Placement

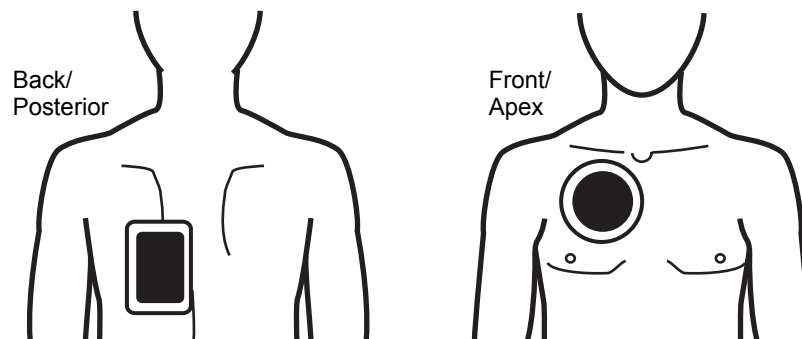

Place the front (apex) pad on the third intercostal space, mid clavicular line on the right anterior chest. The back/posterior pad should be placed in the standard posterior position on patient's left as shown.

Shock Conversion Estimator

Use of a defibrillator shock is currently the best option for terminating ventricular fibrillation and restoring a life sustaining ECG rhythm [1]. Maintaining blood flow through the heart via cardiopulmonary resuscitation (CPR) has been shown to improve the chances of a successful defibrillation [1]. The cessation of blood flow through the heart that occurs when CPR is stopped decreases the likelihood of a successful shock in proportion to the amount of time that has elapsed without CPR [1]. The repeated use of defibrillator shocks that do not restore a life sustaining rhythm may cause additional damage to the myocardium and reduce the patient's chances for survival. The use of an accurate shock outcome predictor can help reduce the duration of CPR interruptions and the number of ineffective (non-converting) shocks delivered.

Properly performed CPR has been shown to increase blood flow to the heart and increase the neurologically intact patient survival rate [2]. Following current rescue protocols that alternate periods of CPR and defibrillator shocks, the rescuer must stop CPR while the defibrillator analyzes the patient's ECG rhythm to determine whether it is shockable. If the rhythm is non-shockable, the rescuer immediately resumes CPR. When the patient's rhythm is shockable, however, the rescuer must withhold CPR for an additional period of time while the defibrillator changes, shocks are delivered, and the outcome evaluated. Should the defibrillator shocks be ineffective, CPR is immediately resumed after the loss of precious seconds without cardiac blood flow augmentation. If the non-perfusing rhythm can be identified as unlikely to convert before the delivery of ineffective shocks, non-CPR time can be reduced and there will likely be an increase in post resuscitation as well as neurologically intact survival. The ability to predict that the current ECG rhythm will not convert may also help reduce the number of non-converting shocks delivered. This reduction in total shocks delivered would reduce the damage sustained by the heart during resuscitation. The Shock Conversion Estimator (SCE) addresses these problems by computing a Shock Prediction Index (SPI) number which measures the probability that a shockable rhythm will be successfully converted by immediate defibrillation. The SPI number is directly related to the AMSA measure developed by the Weil Institute of Critical Care Medicine [3].

The Shock Conversion Estimator algorithm was developed and tested using data collected from a registry of ZOLL AED Pro® and AED Plus® defibrillator field cases. Since the AED Pro and AED Plus defibrillators are first responder units, all patient records correspond to first responder cardiac arrest situations. The defibrillator shock results from these cases were annotated as "converted" if a transient return of spontaneous circulation (tROSC) occurred following the shock. tROSC was defined as post shock ECG rhythms meeting both of the following characteristics:

1. Spontaneous ECG rhythms lasting at least 30 seconds that began within 60 seconds after shock delivery; and
2. Rhythms exhibiting a heart rate of 40 beats per minute or more.

The post shock rhythm was annotated as "non-converted" if it exhibited any other conversion outcome, e.g. VF, VT, and asystole.

The total database consisted of 258 patient records containing 586 shocks. The first 109 patient records were used in the Validation Database which consisted of 251 delivered shocks. The Development Database was constructed from the remaining patient records, 149 patients, resulting in 535 delivered shocks. The Development Database was used to develop the algorithm and to establish the threshold SPI values for 95% sensitivity. The Test Database was used to prospectively validate the performance of the algorithm against the default and other user configurable SPI thresholds.

Figure A-21 on page A-25 presents the sensitivity and specificity curves for the combined datasets. The vertical line indicates the position of the 7.4 mV-Hz default threshold. 7.4 correlates to a sensitivity and specificity of 95% and 57%, respectively. Table A-2, "Accuracy Table of SCE Levels and Corresponding SPI Thresholds," on page A-26 lists the SCE Level settings (HIGH, MEDIUM, and LOW) and corresponding SPI thresholds, sensitivities, and specificities that can be configured on the E Series unit. Column 1 is the SPI threshold in mv-Hz. Columns 2 and 3 are the sensitivity and specificity as described below (expressed in percent).

The preferred treatment for non-converting rhythms may be the delivery of aggressive CPR. The use of the SPI measure to determine when shock treatments are likely to succeed will help minimize time between the advisory decision and the start of CPR. Minimizing non-perfusing time during resuscitation is a key contributor to improving patient outcomes [4].

Sensitivity = $\frac{\text{Number of ECG Rhythms with SPI} > \text{Threshold that were successfully converted}}{\text{Total number of ECG rhythms that were successfully converted}}$

Specificity = $\frac{\text{Number of ECG rhythms with SPI} \leq \text{Threshold that did not convert}}{\text{Total number of ECG rhythms that did not convert}}$

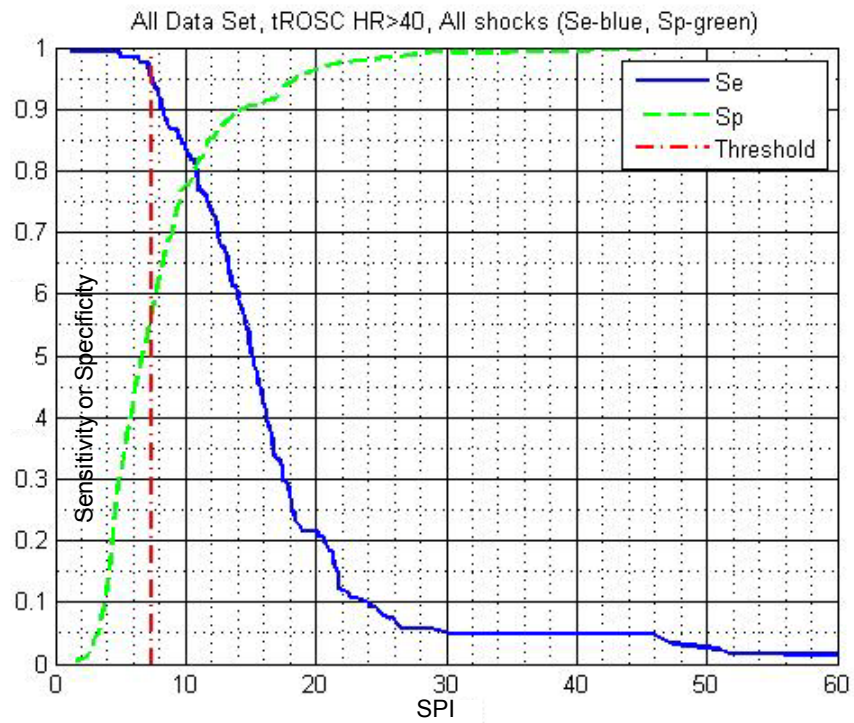

Figure A-21. Sensitivity and Specificity Curves vs. SPI (mV-Hz) for the Combined Datasets

Table A-2. Accuracy Table of SCE Levels and Corresponding SPI Thresholds

SCE Level	SPI Threshold (mV-Hz)	Sensitivity %	Specificity %
HIGH	7.4	95	57
MEDIUM	8.3	90	65
LOW	10.8	80	80

References:

- [1] Eftestol T, Sunde K, Steen PA. Effects of Interrupting Precordial Compressions on the Calculated Probability of Defibrillation Success during Out-of-Hospital Cardiac Arrest. *Circulation* 2002; 105:2270-2273.
- [2] Sota Y, Weil MH, Sun S, Tang W, Xie J, Noc M, Bisera J. Adverse effects of interrupting precordial compression during cardiopulmonary resuscitation. *Critical Care Medicine* 1997; 25:733-736.
- [3] Young C, Bisera J, Gehman S, Snyder D, Tang W, Weil MH. Amplitude spectrum area: measuring the probability of successful defibrillation as applied to human data. *Critical Care Medicine* 2004; 32:S356-S358.
- [4] Wik L. Rediscovering the importance of chest compressions to improve the outcome from cardiac arrest. *Resuscitation* 2003; 58:267-269.

ECG Analysis Algorithm Accuracy

Sensitivity and specificity are expressions of ECG analysis algorithm performance when compared to ECG interpretation by a clinician or expert. Sensitivity refers to the algorithm's ability to correctly identify shockable rhythms (as a percentage of the total number of shockable rhythms). Specificity refers to the algorithm's ability to correctly identify non-shockable rhythms (as a percentage of the total number of non-shockable rhythms). The data in the following table summarizes the accuracy of the ECG analysis algorithm as tested against ZOLL's ECG Rhythm Database.

The algorithm sequence takes approximately 9 seconds and proceeds as follows:

- Divides the ECG rhythm into three-second segments

- Filters and measures noise, artifact, and baseline wander.
- Measures baseline content ('waviness' at the correct frequencies — frequency domain analysis) of signal.
- Measures QRS rate, width, and variability.
- Measures amplitude and temporal regularity ('auto-correlation') of peaks and troughs.
- Determines if multiple 3 second segments are shockable then displays *SHOCK ADVISED* message.

Clinical Performance Results

The performance of the incorporated analysis algorithm in a single analysis sequence satisfies the applicable requirements specified in ANSI/AAMI DF80 (section 6.8.3) and the recommendations by Kerber et al. (Circulation. 1997;95(6):1677).

Table A-3. Clinical Performance Results

Rhythms	Sample Size	Performance Goals	Observed Performance	90% One-sided Lower Confidence Limit
Shockable		Sensitivity		
Coarse VF	536	>90%	>95%	>97%
Rapid VT	80	>75%	>98%	>96%
Non-shockable		Specificity		
NSR	2210	>99%	>99%	>99%
AF, SB, SVT, Heart block, idioventricular, PVCs	819	>95%	>99%	>99%
Asystole	115	>95%	>98%	>97%
Intermediate		Sensitivity		
Fine VF	69	Report only	>88%	>80%
Other VT	28	Report only	>96%	>84%

References:

Young KD, Lewis RJ: "What is confidence? Part 2: Detailed definition and determination of confidence intervals". *Annals of Emergency Medicine*, September 1997; 30; 311-218

William H. Beyer, Ph.D.: "CRC Standard Mathematical Tables 28th Edition," CRC Press, Inc, Boca Raton, FL., 1981, Percentage Points, F-Distribution Table, pg 573.

(This page intentionally left blank.)

APPENDIX B

MEDICAL REPORT CAPABILITY

The unit's medical report capability automatically records incident information for subsequent review and archiving. Data is stored on a removable PCMCIA Type II data card (memory card) for uploading to a properly equipped personal computer or hand held device.

The medical report capability begins recording when the unit is turned on and continues until the unit is turned off. Patient ECG, unit status, date, time and control settings are recorded. Audio recording using a microphone located on the front of the unit is optional.

Data recorded during an incident is retained on the memory card until erased. Shutting the unit off with the memory card installed or removing the memory card from the unit does not erase the data.

PCMCIA Data Card

The memory card is a self-contained, electronic storage unit similar to a floppy disk.

- Do not subject the card to extreme temperatures.
- Do not immerse the card in liquids.
- Do not place the card near magnetic objects.
- Do not place heavy objects on the card.
- Protect the connector located on the card from physical damage.

Contact ZOLL Technical Service Department for the current list of supported PCMCIA cards.

You can store up to two hours of incident data (ECG and unit status) or up to 38 minutes of incident data and simultaneous audio recording on one 4-megabyte memory card. The E Series can also be configured to record the continuous SpO₂ waveform and/or the continuous EtCO₂ waveform. Overall recording time on a 4 Mb memory card is reduced by approximately 20 minutes when recording SpO₂ waveform data, and by 12 minutes when recording EtCO₂ waveform data. ZOLL recommends that you keep a spare memory card with the unit at all times and that you change the memory card after each incident.

Installing the PCMCIA Data Card

Check that there is no physical damage to the connector edge and that the connector edge is clean and free of dirt and debris. Insert the memory card into the right rear slot located on the top of the unit. The label side should be

facing you. Slide the card into the unit until it is firmly seated in the card slot.

Note: Closing the PCMCIA slot's protective cover does not guarantee that the card is fully inserted. Make sure the card is firmly seated before you close the cover.

To remove the card, press the release button and pull the card out of the unit. If the memory card is removed while the unit is on, the unit still operates properly but no event information is recorded.

Erasing a Memory Card

If the unit is configured to allow card erasure, memory cards can be erased. See the E Series Configuration Guide for further details on the ALLOW CARD ERASE configuration option.

To erase card memory:

1. Turn off the unit.
The unit must remain turned off for at least 10 seconds.
2. Hold down the left-most softkey for 4 seconds while turning selector switch to MONITOR (ON for AED).
The E Series powers on in System Utilities mode.
3. Press the **Erase Cards** softkey.
4. Press the **Next Item** softkey to select YES.
5. Press the **Enter** softkey.

The E Series unit erases the card and displays the ERASING CARD message. A progress bar appears while erasing the card. Next, the unit verifies the card to ensure that the card was properly erased. During this verification, a new progress bar and the message VERIFYING CARD appears. When the card is completely verified, the CARD ERASED message is displayed.

The unit can be turned off, or the card removed, during the verification phase without affecting either the card or the unit. ZOLL strongly recommends that cards be verified again after erasure to ensure against possible data loss or corruption.

If the No Card Inserted message displays, insert a PCMCIA into the card slot. If the Card Operation Failed message displays, the card is damaged. In this case you should either:

- Press the **Enter** softkey to erase another card.

- Press the **Next Item** softkey and then the **Enter** softkey to exit.

When finished erasing memory cards, return the unit to normal use by powering the unit off and then back on.

Transferring Data to a PC with a PCMCIA Data Card Reader

RescueNet Code Review for Windows software version 4.00 or later must be installed on the PC to access any information stored on PCMCIA cards.

Remove the data card from the unit. Insert the card into the PCMCIA data card reader on the PC.

For instructions on information retrieval and PC equipment requirements, refer to the RescueNet Code Review Enterprise Reference Manual.

Uploading Memory Card Data or Trend History to a PC or Handheld

Data can be uploaded to a PC or handheld device via two transmission methods. The RS232 serial port allows transfers using cable connections. Bluetooth wireless technology is available to allow wireless communication. Specific details about hardware and settings for each method are described below.

On a PC, you can use RescueNet Code Review software as the data communications package or another utility software package such as HyperTerminal for data transfer.

RescueNet Code Review software must be installed on the remote PC to access any information stored on PCMCIA cards. For instructions on information retrieval and PC equipment requirements, refer to the RescueNet Code Review Enterprise Reference Manual.

ZOLL Data Relay software must be installed on the remote handheld device or PC to access any data transmitted from the E Series unit. Refer to the ZOLL Data Relay user documentation for installation and operating instructions.

After memory card transmission, file names created by the communications program on your PC have the following format:

ZEsssssss_YYYYMMDD_HHMMSSL.crd

where:

- sssssss = Unit serial number
- YYYYMMDD= Year, month and day of transmission
- HHMMSS = Hour, minute, and second of transmission
- L = A unique identifier associated with the file that increments sequentially through the alphabet (e.g., A, B, C, etc.)

Example: ZE12345678_20050425_183005A.crd

Unit 12345678 April 25, 2005, 6:30:05 PM.

Note: Upload times vary. For example, a 2 MB card containing 30 minutes of recorded incident and audio data may take up to 10 minutes to upload at a baud rate of 38,400 bps. At a baud rate of 9600 bps, the same upload may take up to 40 minutes.

RS-232 Serial Port

The E Series unit provides serial communication capability through an RS-232 serial port on the rear panel.

- For data transmission through the RS-232 serial port to a handheld device, you must use a ZOLL RS-232 data transfer cable. For connection to a handheld device, a compatible serial data cable must be connected to the ZOLL data cable. The ZOLL RS-232 data cable terminates in a female DB9 connector; the serial data cable that connects to the handheld must terminate in a male DB9 connector. A null modem adapter may be required to connect the two cables.
- For data transmission through the RS-232 serial port connection to a PC, a 9-pin to 25-pin adapter may be required.

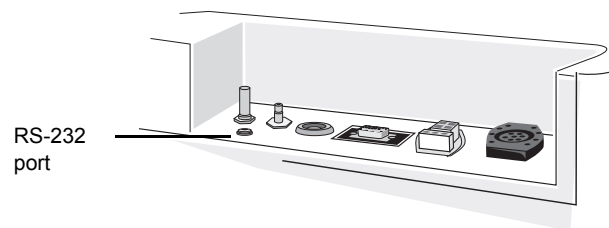

Bluetooth Transceiver (Optional)

Some E Series units include a wireless communication option that uses Bluetooth technology to communicate with a ZOLL-approved, Bluetooth-equipped host system (handheld device or PC running ZOLL Data Relay software).

E Series units that are equipped with a Bluetooth transceiver have a status LED on the top of the unit that indicates power (green) and transceiver activity (blue).

LED activity	Condition
Solid green	E Series unit is supplying power to the transceiver.
Solid blue	Bluetooth transceiver is negotiating connection with a receiver. Bluetooth transceiver is connected to a receiver.
Flashing blue and green (intermittent)	Bluetooth transceiver is transmitting data to a receiver.

Communication Settings

You must configure the same communication settings on both the E Series unit and the PC or hand-held device for proper data transmission. The correct communication settings are:

Parameter	Appropriate Setting
Baud rate (bits per second)	115 200 bps 38 400 bps (default) 9600 bps
Data bits	8
Parity	None
Stop bits	1
Flow control	None

See the E Series Configuration Guide for instructions on how to configure the E Series baud rate.

Transferring Data

1. Turn the selector switch to OFF.
2. After 10 seconds, press and hold the left-most softkey and turn the selector switch to MONITOR (ON for AED units).

After approximately 4 seconds, the unit powers on in System Utilities mode.

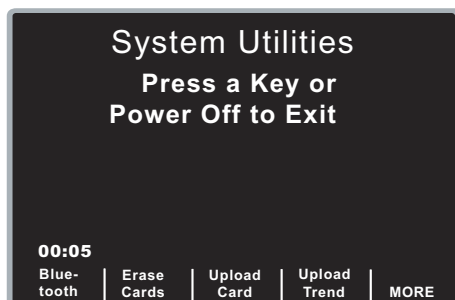

3. If uploading a data card, insert the data card to be uploaded into the rear PC card slot on top of the unit.
4. Activate the communication software on the receiving host system. If not done already, prepare the host system to receive a data file by entering the communications settings as noted above.
5. Press the **Upload Card** or **Upload Trend** softkey. If you have selected Upload Card, a list of all calls stored on the data card will be displayed (after a brief pause, while the data is read). Select either an individual call from the list and then press the **Upload Call** softkey, or press the **Upload Card** softkey to

upload the entire contents of the data card.

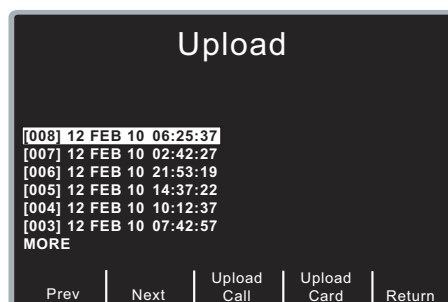

If the device is equipped with Bluetooth, a transmission mode selection appears, prompting you to choose either Bluetooth or RS-232. If it is not equipped with Bluetooth, then the Upload screen appears; go directly to Step 7.

6. Select either Bluetooth or RS-232.

The main Upload screen displays.

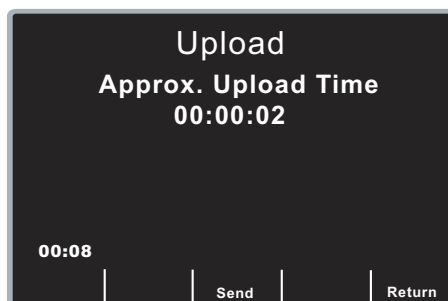

7. Press the **Send** softkey to begin data transmission. The unit displays a progress bar that indicates the percentage of data transferred to the PC.

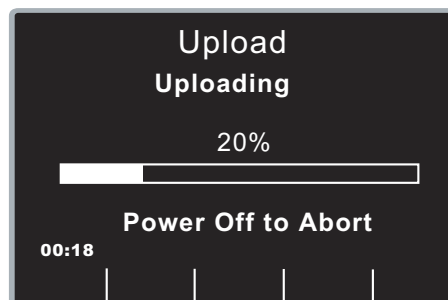

To stop data transmission, turn the selector switch to OFF.

Note: You must retransmit card data if the unit is shut off before all data stored in the card has been transmitted.

Following a successful transmission, the unit displays the Card Uploaded screen. To upload another card, remove the current card, insert a new card, and press the **Send** softkey again. (The **Send** softkey appears when the new card is inserted.)

Activating Automatic Data Transmission

The unit can be placed into realtime mode for automatic data transmission. In this mode, you can transmit data in real time to a remote device running ZOLL Data Relay software. The remote device in turn sends the data to a ZOLL Data Relay service for appropriate processing and formatting. In realtime mode, the E Series unit displays two asterisks (*) in the top left-hand corner of the screen. When the unit is transmitting trend data or a 12-lead patient record (if equipped), the asterisks flash alternately; otherwise the asterisks remain static.

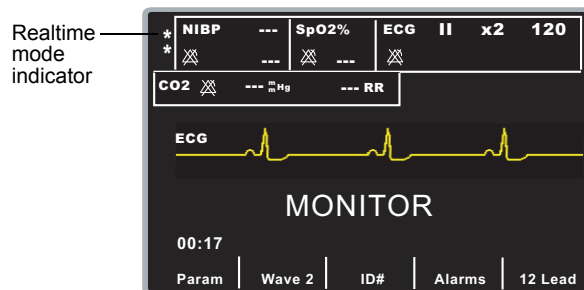

In realtime mode, the E Series unit only transmits trend data collected since the unit was powered-up, and does NOT transmit all trend data stored in memory. To transmit all trend data, you must initiate transmission using the **Upload Trend** softkey in the System Utilities screen. Until you exit realtime mode, trend data is transmitted each time a new trend record is recorded.

In realtime mode, the E Series unit transmits 12-lead data to the host system automatically. However, if the “Auto Transmit after 12-lead Analysis” option is enabled, the E Series unit displays the Transmission Setup screen after the 12-lead data has been acquired. If you press the **Dial Phone #** softkey, the unit transmits the 12-lead data again; press the **Cancel Xmit** softkey to prevent redundant data transmissions and return to the 12-lead menu.

If you are using realtime mode on a regular basis, you can disable the “Auto Transmit after 12 Lead Analysis” option to eliminate the additional Transmission Setup screen; see the E Series Configuration Guide for more information.

To change the automatic data transmission port:

1. Press the **Param** softkey from the main menu to display the Parameter menu.

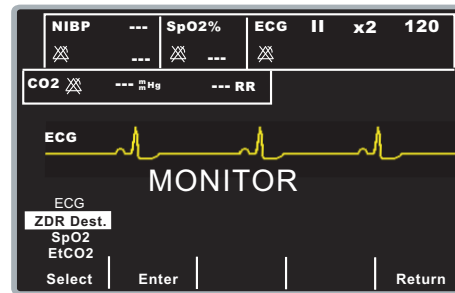

2. Use the **Select** softkey to scroll through the available parameter options to highlight the **ZDR Dest.** (realtime) destination option, and press the **Enter** softkey.

The unit displays the Realtime Channel screen.

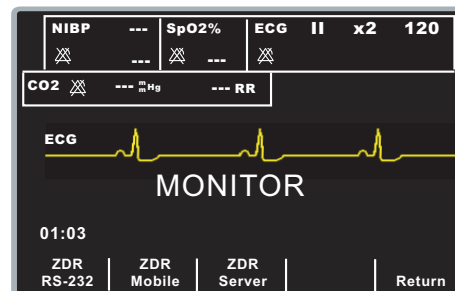

3. Press the **ZDR RS-232** softkey if you are transmitting data via an RS-232 serial cable, or press the **ZDR Mobile** softkey if are transmitting data via Bluetooth to a PC or handheld device.
4. Press the **Return** softkey to return to the main menu.

To activate automatic data transmission:

1. Press the **SUMMARY** button on the front panel to display the Summary menu.

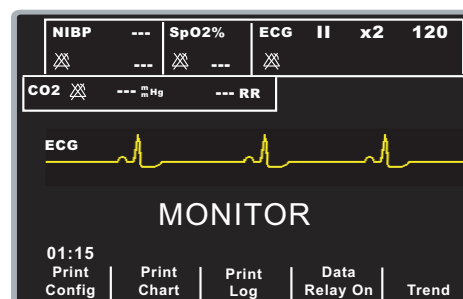

2. Press the **Data Relay On** softkey to activate automatic data transmission.

Note that the unit displays the realtime mode indicator in the upper left-hand corner of the screen. In addition, the **Data Relay On** softkey label changes to **Data Relay Off**.

- To deactivate automatic data transmission, display the Summary menu (by pressing the **SUMMARY** button) and press the **Data Relay Off** softkey

Note: If you change the destination port while a record is already being transmitted, that transmission continues to the previously selected port. All other records in the queue will be transmitted to the newly-selected port.

Note: If you change ports from Bluetooth to RS-232, and then you want to change back to Bluetooth, the host system must reestablish a connection with the E Series unit. However, power to the Bluetooth module is not turned on again until a record starts transmitting out the Bluetooth port.

- Press the **Patient Records** softkey to display the Patient Records menu.

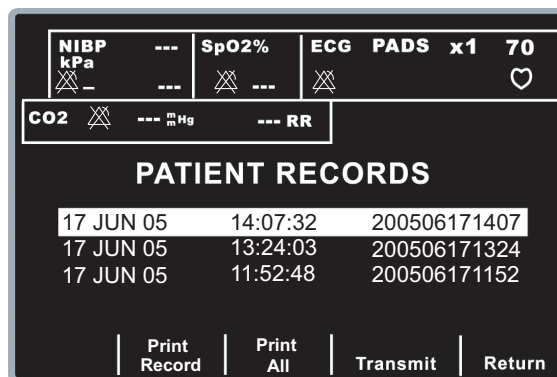

Transmitting 12-Lead Patient Records

You can transmit 12-lead ECG patient records to a remote host system running ZOLL Data Relay software without placing the E Series unit into Realtime mode.

- With the E Series unit in Monitor mode (ON for AED units), press the **12 Lead** softkey to access the 12 Lead menu.

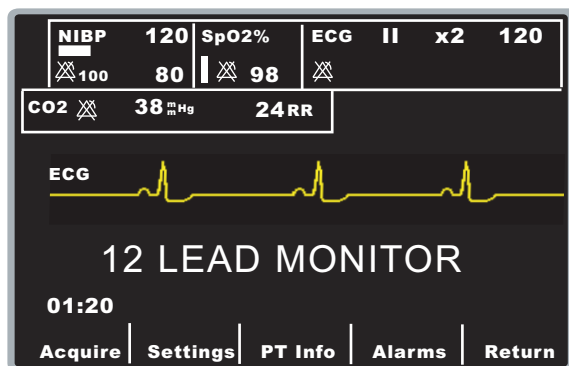

- Press the **PT Info** softkey to access the Patient Information menu.

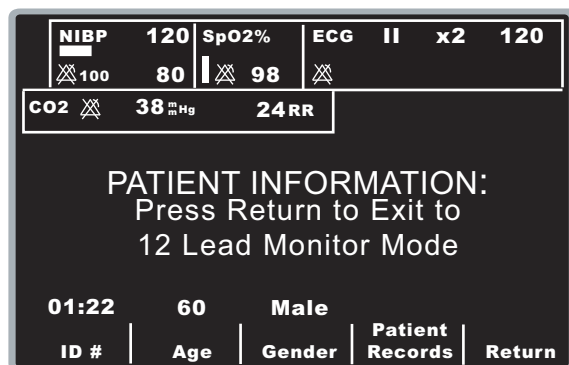

- Select a Patient record and press the **Transmit** softkey.
- Select the Data Relay option and press the **Dial Phone#** softkey.

If you are transmitting via Bluetooth, then the green power LED on the E Series unit illuminates. You must now establish a connection between the host system and the E Series unit.

Troubleshooting

If configured, the unit displays the following messages when it encounters problems during data transmission.

Message	Possible Causes and Corrective Action
<i>CARD FULL</i>	Data card is full. No more data can be stored on the card, but the unit continues to operate. This prompt is only issued when the unit is not analyzing or charging. Insert another card, or print event data on stripchart recorder.
<i>INSERT CARD</i>	Card is not installed or not seated properly in the unit.
<i>CARD NOT ERASED PROPERLY / ERASE CARD</i>	An Erase Card operation was interrupted, or the card is damaged. The unit operates, but no data is being stored. Erasing the card may allow return to normal data storage operation.
<i>CARD WRITE-PROTECTED</i>	The card is write-protected. The unit operates, but no data is being stored. Adjust the write-protect tab on the card to allow writing.

Message	Possible Causes and Corrective Action
<i>NOT AN E SERIES DATA CARD</i>	The wrong type of card is installed. The unit operates, but no data is being stored. Insert the correct type of card.
<i>REPLACE CARD</i>	The wrong type of card type is installed, or the card is defective. The unit operates, but no data is being stored. Erasing the card may allow return to normal data storage operation
<i>AUDIO NOT RECORDING</i>	Note: Only possible with the audio recording option. Data card has been removed from the unit while the unit is turned on. The unit does not record event or audio information.
<i>CARD REMOVED</i>	Card was removed from PCMCIA slot or is not seated properly. Reinsert card.
<i>EMPTY CARD</i>	Empty data card inserted into PCMCIA slot, or card was erased. Record data on card before transmission, or insert different card.
<i>NOT A DATA CARD</i>	The wrong type of card is installed. Insert a different card
<i>VERIFICATION FAILED</i>	The card was not erased successfully and is defective. Insert a different card.
<i>HOST FAULT UPLOAD ABORTED</i>	Remote device aborted transmission. Ensure remote device is on and ready to accept data. Transmission aborted because the host system detected an error or user cancelled transmission via communication program. Check communication package on the remote device or PC for the source of the error. Retry.

Message	Possible Causes and Corrective Action
<i>SERIAL FAULT or UPLOAD ABORTED</i>	E Series unit aborted transmission. Data retrieval pre-empted by other E Series operations (such as alarm conditions or defibrillation activity); unit could not retrieve data from memory. Wait for E Series events to clear and retry. Ensure remote device is on and ready to accept data. Check communication settings on unit and on the host system to ensure they match. For serial data transmission: <ul style="list-style-type: none"> Check and secure the ZOLL RS 232 data transfer cable at the back of the unit, the ZOLL cable connection to the RS-232 cable, as well as the RS-232 cable connection at the back of the PC. For Bluetooth data transmission: <ul style="list-style-type: none"> Move the host system closer to the E Series unit and retry.
<i>CARD PREVIOUSLY UPLOADED</i>	User inserted a valid data card that was already uploaded successfully. Data on card not erased. Use a different data card, erase the data on the card you are using, or resend the data again.